



# Research On Biodegradable Lubricant in Combustion Engine

**Muhammad Luqman Haikal Hamidon<sup>1</sup>, Rozita Jumadi<sup>1</sup>, Amir Khalid<sup>1</sup>,  
 Norrizam Jaat<sup>1\*</sup>, Hamidon Salleh<sup>2</sup>, Syahrullail Samion<sup>3</sup>**

<sup>1</sup>Centre of Automotive and Powertrain Technology, Faculty of Engineering Technology,  
 Universiti Tun Hussein Onn Malaysia, 84600 Pagoh, Johor, MALAYSIA

<sup>2</sup>Centre for Energy and Industrial Environment Studies (CEIES), Faculty of Mechanical and  
 Manufacturing Engineering, Universiti Tun Hussein Onn Malaysia, Parit Raja, Batu Pahat, 86400 Johor, MALAYSIA

<sup>3</sup>Faculty of Mechanical Engineering (FME),  
 Universiti Teknologi Malaysia, Skudai 81310 Skudai Johor, MALAYSIA

\*Corresponding Author

DOI: <https://doi.org/10.30880/japtt.2022.02.02.006>

Received 20 July 2022; Accepted 05 October 2022; Available online 31 December 2022

**Abstract:** Lubricants predominantly used to reduce friction and gain smooth functioning of a vehicle. Biodegradable lubricants are perceived to be alternative to mineral oil lubricants because of their properties and biodegradability. This review paper discusses the effect of biodegradable lubrication in term of emission performance, wear, friction and viscosity effect to the internal combustion engine using multiple types of biodegradable lubrications. Bench wear test was conducted using Yamaha, ET 950 to carry out the effect of the biolubricant in spark ignition (SI) engine. The bench test was conducted under several conditions: pressure, 3.0 MPa; sliding speed, 0.20 m/s; sliding stroke, 80 mm; room temperature, >25°C. The second experiment were conducted with 100 percentage SAE 40, palm oil and palm oil (14%) + castor oil (86%) blend as its crankcase lubricant using four stroke compression ignition (CI) engine. A thermocouple was used to measure the parameters temperature every 5 minutes' interval with the engine operating for an hour under no load, 2.5 kg, 5 kg, and 7 kg load condition. The emission performance was run using neem oil blends as samples. The brief discussion is made on emission performance, fuel efficiency, viscosity index and coefficient of friction. Also, deduction was made for the temperature of crank case oil, coolant and the exhaust gas.

**Keywords:** Effect, biodegradable lubricant, internal combustion engine, spark ignition engine, compression ignition engine

## 1. Introduction

About 1% of the total mineral oil consumption is used to formulate lubricants [1-5]. Lubricant is a substance that is introduced to reduce friction between surfaces in mutual contact [6-12]. It also has the function of transmitting forces, transporting foreign particles or heating or cooling the surfaces. It also acts to prevent corrosion, keeps moving part apart and protect against wear [13-15]. A lubricant may exist in gaseous, liquid, semisolid or solid form [14-15].

Mineral based lubricants are released into the surrounding during use, spills and disposal. It is not biodegradable and has high toxic content. It gives big impacts to the environment as it risks the environment by affecting farming and civil construction, vegetation and microorganisms. In addition to that, disposing mineral oil could also endanger aquatic ecosystems [15-16]. This situation creates concern to study and introduce environmentally friendly biodegradable lubricant as an alternative to petroleum-based lubricants [17]. The objectives of this case study are to study and introduce biodegradable lubricant as an alternative lubricant despite mineral oil lubricant that is widely used nowadays.

Besides that, this case study is conducted to prove the positive effect of biodegradable lubricant in terms of the performance of internal combustion engine (ICE) for both CI and SI engine. Apart from that, researchers would also want to create awareness among societies regarding green environment with the implementation of biolubricant replacing the conventional petroleum-based lubricant [18-21]. This review paper is to find out the effect of biodegradable lubrication in term of emission performance, wear, friction and viscosity effect to the internal combustion engine using multiple types of biodegradable lubrications. Bench wear test was conducted using Yamaha, ET 950 to carry out the effect of the bio lubricant in SI engine [22-24]. The bench test was conducted under several conditions: pressure, 3.0 MPa; sliding speed, 0.20 m s<sup>-1</sup>; sliding stroke, 80 mm; room temperature, >25°C. The second experiment were conducted with 100 percentage SAE 40, palm oil and palm oil (14%) + castor oil (86%) blend as its crankcase lubricant using four stroke CI engine. A thermocouple was used to measure the parameters temperature every 5 minutes' interval with the engine operating for an hour under no load, 2.5 kg, 5 kg and 7 kg load condition. The emission performance was run using neem oil blends as samples [25-27].

## 1.1 Biodegradable Lubricant

Biodegradable is defined as the capability of a substance or object to be decomposed by bacteria or other living organisms and thereby avoiding pollution. Biodegradable lubricants are made from plants such as palm, rapeseed [9], coconut, neem and pongamia pinnata [19]. All these different crop oils are considered as potential alternative biolubricants. The oil contains statistics of some non-edible and edible seeds are portrayed in Table 1 below. Some of the most important properties necessary for a satisfactory biolubricant are the following [20]:

- i. High boiling point
- ii. Low freezing point
- iii. High resistance to oxidation
- iv. Thermal stability

**Table 1 - Oil content statistics of some non-edible and edible oil seeds [15,20]**

Sl. No.	Non-edible species	Oil content (% of volume)	Edible species	Oil content (% of volume)
1	Jatropha	40-60	Rapeseed	38-46
2	Neem	30-50	Palm	30-60
3	Karanja	30-50	Peanut	45-55
4	Castor	45-60	Olive	45-70
5	Mahua	35-50	Corn	48
6	Linseed	35-45	Coconut	63-65
7	Moringa	20-36	-	-

Besides that, vegetable oil lubricants also known for having better anti-wear properties compared to mineral oils [17]. Based on the previous researches made, biolubricants are reported to supply better lubricity than petroleum-based oils. Moreover, biolubricants can be efficient and inexpensive substitutes to petroleum-based oils [18-21]. The emission performances of biolubricants have been studied by several researchers by using a reciprocating universal wear machine and a two-stroke engine [21]. Researchers investigated the tribological properties of palm oil and mineral oil-based lubricants and found that vegetable oil-based lubricant is more effective in reducing the emission level for CO and HC gases. Another study observed the tribological properties of oil samples which are coconut and palm oils as lubricants that were collected from the engine at regular interval and evaluated by means of four ball testers [13]. This study also reported and proved the positive effects and results of vegetable oil lubricants against the mineral oil lubricant. Another research found that with the use of vegetable oil as a lubricant, there was a reduction in the temperature of crankcase oil, coolant and the exhaust gas temperature at various load conditions [22-23].

Research on biodegradable functional lubricants is emerging as one of the top priorities in lubrication. Many studies have been conducted to prove the effect on the usage of biodegradable lubricants to the performance of internal combustion engine especially the emission level for both SI and CI engine. Vegetable oil such as palm oil, coconut oil and neem oil are the potential biodegradable lubricants being used for this study.

## 2. Experimental Setup

### 2.1 Material

Different materials are used to run different type of experiment. Few experiments were conducted in order to prove the effect of biodegradable lubrication in lubricating system of internal combustion engine. For this experiment, palm oil as vegetable oil lubricant is used in the test with the mineral oil-based lubricant. For the experiment on tribological and emission performance of palm oil and mineral oil, the upper piston ring (UPR) and lower piston ring (LPR) from

ET-950 Yamaha Generator (two-stroke engine) were used for bench wear test. Only the UPR was coated with hard chromium [21].

### 2.1.1 Apparatus and Procedure

The wear and friction tests were conducted using a reciprocating universal wear machine followed by a two-stroke gasoline Yamaha portable generator set, ET 950. A schematic diagram of the machine and the general arrangement of the experimental setup are shown in Fig. 1 and Fig. 2, respectively. The machine consists of a reciprocating block. It provides reciprocating movement by immersing the flat plate into the lubricant through an oil bath fitted with both the block and plate to be tested. The tests were run twice and the average results of the oil samples were taken. The lube oil ratio to the engine fuel was kept the same at 1:50. Then, acetone is used to clean the tested ring by using ultrasonic method before being dried and weighed using an electronic balance. The wear loss of the ring for both UPR and LPR was obtained by the difference in weight before and after the test run using the Yamaha generator, two-stroke of the ET series, ET 950. The following parameters were technically set before the test: using constant load 0.4 kW for wear test but different load for exhaust emission at constant speed 2800 rpm [21-22].

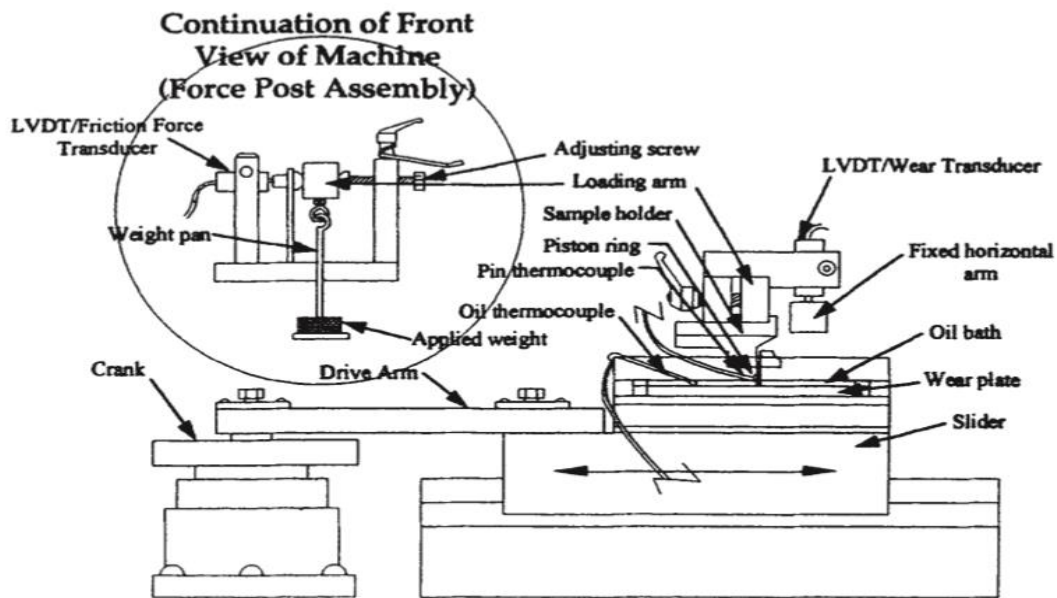

Fig. 1 - Schematic diagram of the testing machine [21]

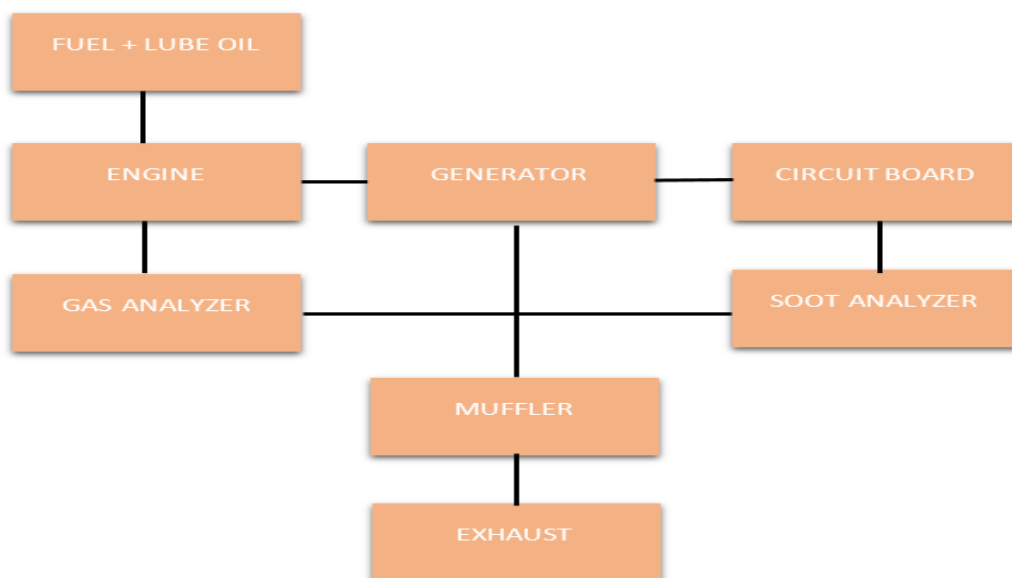

Fig. 2 - General arrangement of the experimental setup [21]

## **2.2 Biolubricant Test on Four-Stroke Engine (For CI Engine)**

In this experiment, the test was conducted by mounting the thermocouple in the crankcase drain plus, gas outlet to exhaust and coolant outlet. For the crankcase lubricants, 100 percentage SAE 40, palm oil and palm oil (14%) + castor oil (86%) blend. The crankcase oil temperature, exhaust gas temperature and engine coolant outlet temperature were measured by using a thermocouple at every 5 minutes' interval under no load condition, 2.5 kg, 5 kg and 7.5 kg for an hour. The tests were conducted for each lubricant and temperature values were measured and plotted in graphs. The specification for the engine is: four stroke single cylinder direct injection CI engine, 8 HP (5.9 kW), 1800 rpm speed, bore diameter 87.5 mm and stroke 110 mm [23].

## **2.3 Emission Test on Single Cylinder CI Engine**

In order to evaluate the emission performance of the vegetable oils, neem oil blends were used as samples to be compared with mineral oil. Agitation apparatus was used to mix the samples with the base lubricant for 45 minutes for homogenization. Each sample was prepared for the average amount of 1.5 litres. N10, N15 and N20 represent the percentage of neem oil esters mixed with SAE 20W-50. An engine with rope brake dynamometer was used to test for any changes in the performance such as emission characteristics. This engine is a Piaggio Ape, single cylinder CI engine with the following specifications: displacement = 395 with maximum torque and power 2000 rpm and 3400 rpm, respectively, using air cooled cooling type [24].

## **3. Effect of Biodegradable Lubricant to SI and CI Engines**

Biodegradable lubricants affect the performance for both SI and CI engine in few ways. The results are divided into two sections, SI engine and CI engine.

### **3.1 Spark Ignition Engine**

#### **3.1.1 Fuel Efficiency Test on Four Stroke SI Engine**

Triglyceride is one of the properties of vegetable oils without additive. Due to its presence, the fuel efficiency of vegetable oils is higher if being compare to the fully formulated mineral oil. This is because of the superior boundary lubricating properties of triglycerides. According to the previous study [22-23], fuel efficiency by the four-stroke engine lubricated with palm oils is higher compare to the engine oil.

#### **3.1.2 Viscosity Test on Four Stroke SI Engine**

Viscosity of a fluid is a measure of its resistance to gradual deformation by shear stress or tensile stress. The viscosity of vegetable oil is lower than the mineral oil. However, vegetable oil evinces a higher number of viscosity index compared to the mineral oil. This is caused by the stronger intermolecular bond of triglycerides with the increase of temperature. In comparison of several types of vegetable oils, castor oil shows the loftiest viscosity than the palm oil and coconut oil [21-22].

#### **3.1.3 Coefficient of Friction Test on Two Stroke SI Engine**

Coefficient of friction for vegetable oil is higher than mineral oil. This property may be caused by the compositions of palmitic and free fatty acid that leads to corrosion of the mating surface. Affected by the lower boundary effect and/or breakdown of boundary lubrication due to lower viscosity [21-22].

#### **3.1.4 Engine exhaust emission test on SI engine**

By referring to the Fig. 3, 4 and 5, the actual engine test results can be analysed. The results illustrate the variation of different exhaust gases as a function of power. For the vegetable oil, low emission is produced as shown in Figure 1(a). The concentration of CO<sub>2</sub> is low due to the efficient burning of the oil during the combustion process. The concentration of O<sub>2</sub> is vice versa since the molecules of O<sub>2</sub> presence in the vegetable oil (oil A) and helps in increasing the efficiency of the combustion process inside the combustion chamber. Carbon monoxide and gaseous hydrocarbon are emitted during the emission process due to incomplete combustion of the fuel. With the use of vegetable oil, low emission of HC and CO gases are observed as illustrated in Fig. 4 and 5, respectively. This shows that complete combustion occurred throughout the process [21-25].

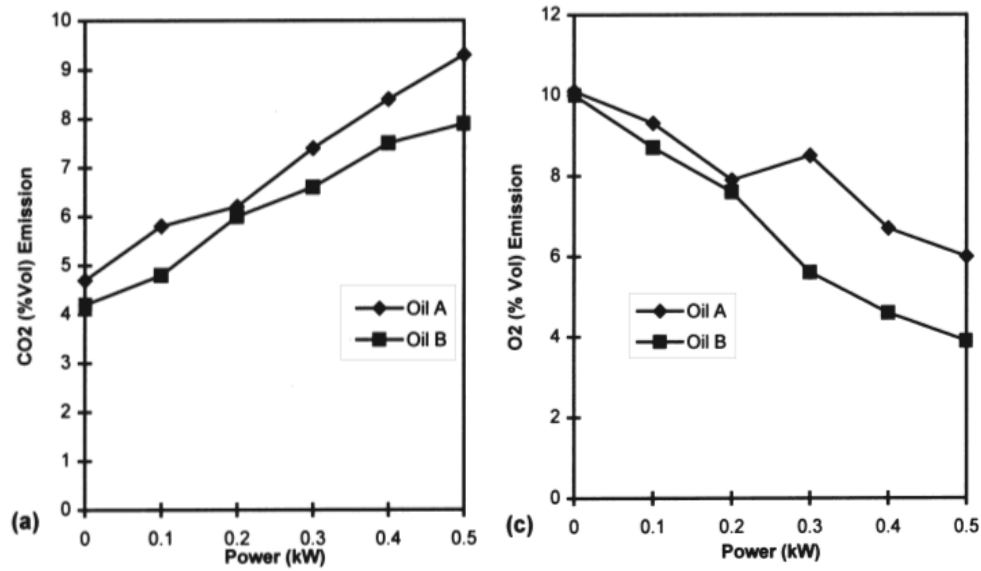

Fig. 3 - Exhaust emissions versus power (a) CO<sub>2</sub>; (b) O<sub>2</sub> [21]

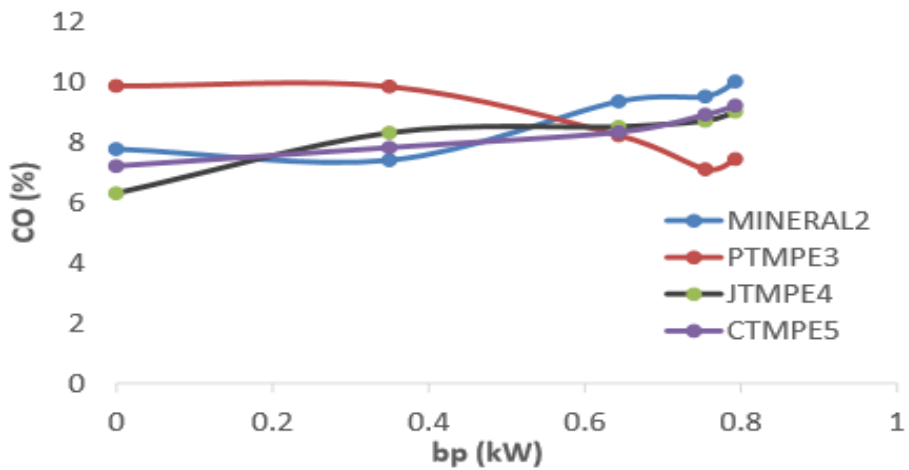

Fig. 4 - Exhaust emission (CO) versus power [25]

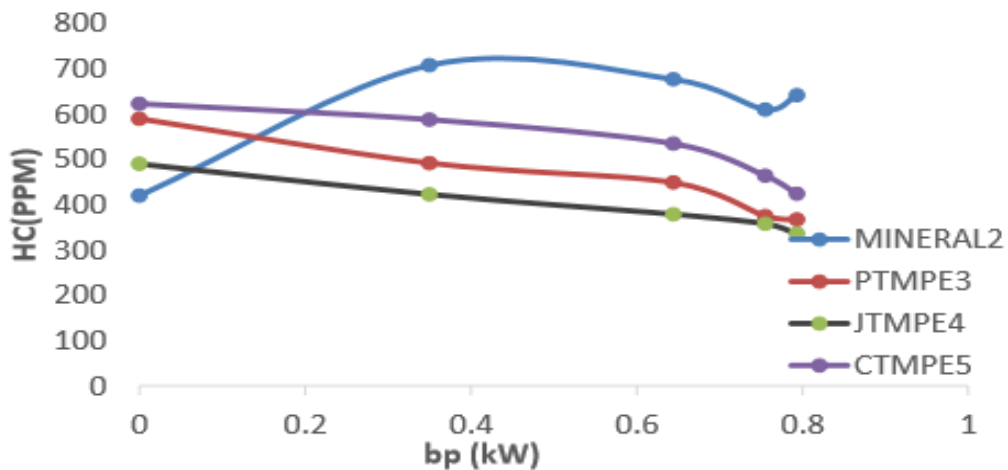

Fig. 5 - Exhaust emission (HC) versus power [25]

### 3.2 Compression Ignition Engine

#### 3.2.1 Crankcase Oil Temperature Test on CI Engine

Fig. 6 shows that crankcase oil temperature was found to increase under high load condition. The temperature of lubricants also increases. However, the temperature of vegetable oil remains lower than the mineral oil ranging from no load condition until full load condition. This happens due to the hydrodynamic lubrication that cause the lower friction force acting between the piston and the cylinder wall. Nevertheless, the hydrodynamic lubrication cannot be affected by the oil temperature and viscosity [24].

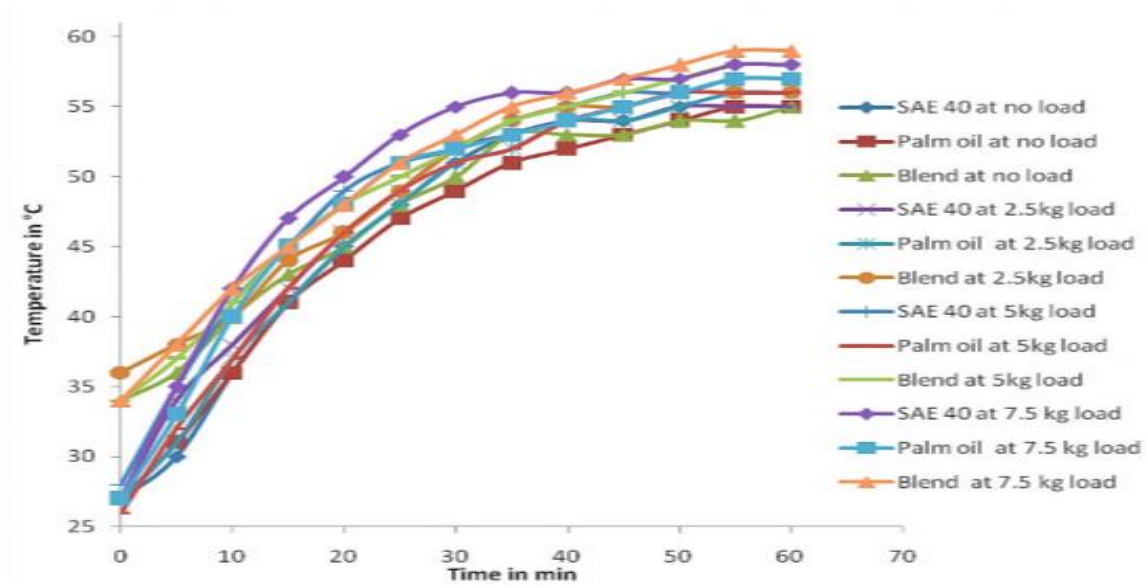

Fig. 6 - Crankcase oil temperature versus time [24]

#### 3.2.2 Coolant Temperature Test on CI Engine

The difference in coolant temperature is shown in Fig. 7 with time for different loads. The figure shows that coolant temperature was found to increase under high load condition. As load increases, the friction between the moving parts of the engine also increases. During the process, there is a reduction in friction happening to the low friction force acting between piston and cylinder wall which results in friction losses and friction heat generation to be reduced. Therefore, coolant temperature of vegetable oil is lower than that of mineral oil when it is used as lubricant as observed from the graph [24].

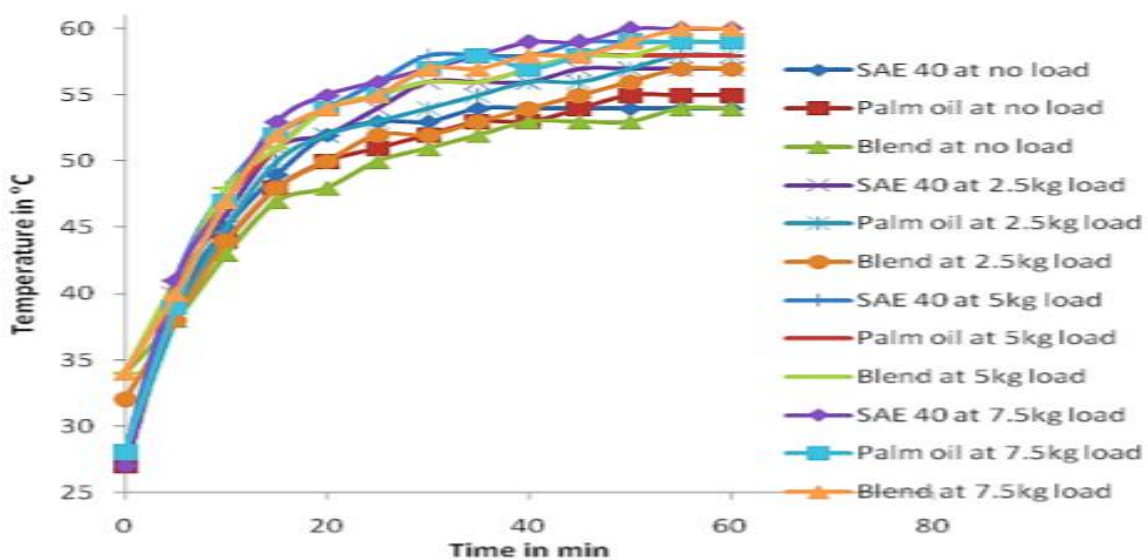

Fig. 7 - Coolant temperature versus time [24]

### 3.2.3 Exhaust Gas Temperature Test on CI Engine

Next, the variation of exhaust gas temperature with time and distinct load conditions is displayed in Fig. 8. The rise in temperature of exhaust gas indicates the occurrence of complete combustion. By referring to the graph, it can be seen that the exhaust gas temperature for the mineral oil is higher compared to the vegetable oil. The reduction in coolant temperature affect the exhaust temperature of the vegetable oil, causing it lower than the mineral oil [24-26].

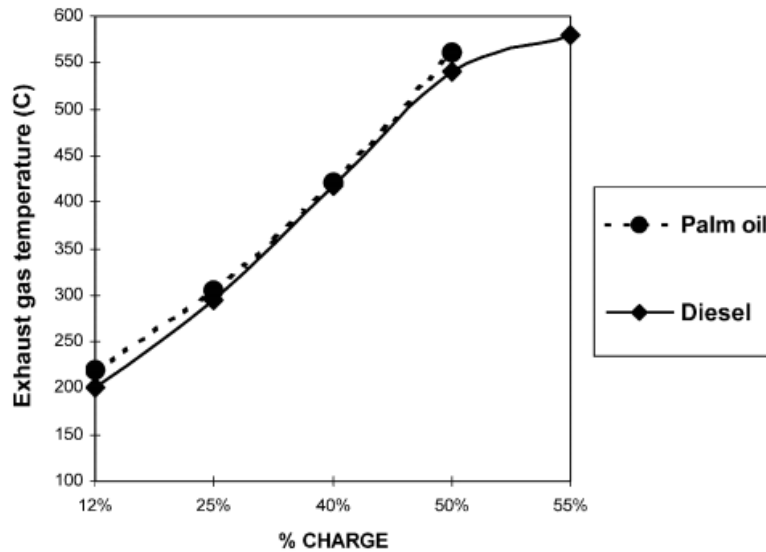

Fig. 8 - Exhaust gas temperature versus % of charge [26]

### 3.2.4 Engine Exhaust Emission Test on CI Engine

Fig. 9 shows the comparison of emission using different samples [18]. The figure illustrates that the graph of CO emission is in decreasing trend as the load conditions increasing. This is caused by the additions of vegetable blend with the mineral oil. The lowest CO emission is possessed by the 50% palm-mineral oil blend compared to the other blend and mineral oil. The use of 50% mineral-palm oil blend shows the smallest value of HC emission for CI engine as complete combustion occurred throughout the process, while the lowest HC emission is obtained by the application of 75% palm-mineral oil blend. Meanwhile, the emission level of O2 exhibits a decreasing trend since most of O2 concentration have been used for combustion [24-27].

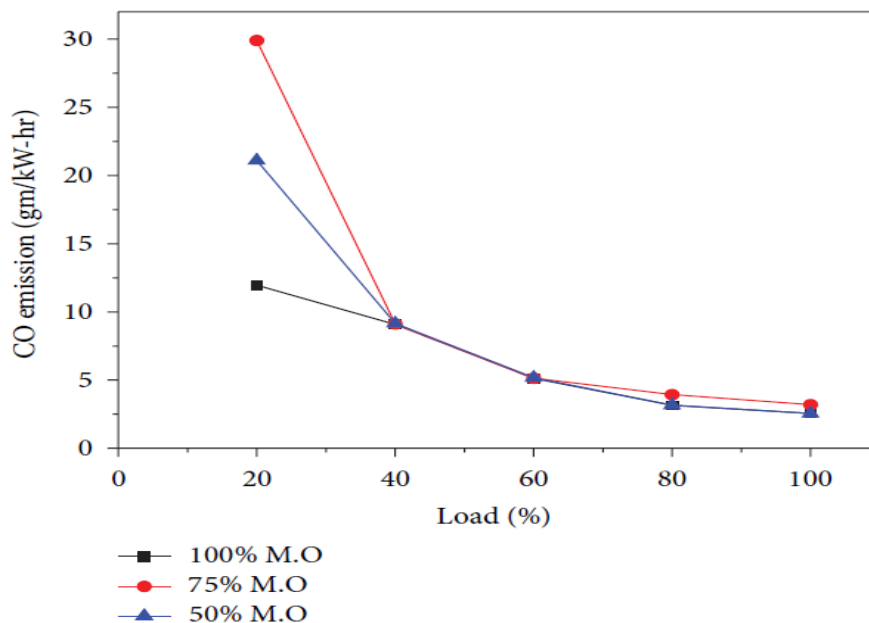

Fig. 9 - Comparison of CO emission under different load [27]

## 4. Conclusion

Biodegradable lubricant is renewable lubricants that is biodegradable, non-toxic, and emits net zero greenhouse gas. This study largely covers the effect of biodegradable lubricant in lubricating system in internal combustion engine for both SI and CI engine. Overall, biolubricants were found positively affect the performance of the engine. The following conclusions can be drawn from this study:

- i. The use of biodegradable lubricants affected the fuel efficiency, kinematic viscosity coefficient of friction and the engine exhaust emission in SI engine. The fuel efficiency was observed to be more efficient compare to the mineral oil due to the presence of triglycerides. The viscosity index for biolubricants was shown higher than the mineral oil. Biolubricants also affect the result of the coefficient of friction. Besides, the results for engine exhaust emission between the biolubricants and mineral oil were comparable under specified condition.
- ii. The results for using biodegradable lubricants in CI engine affect the crankcase oil temperature, engine coolant outlet temperature and exhaust gas temperature at every time interval. It was found that with the use of biolubricant, there was a reduction in temperature of all properties. The emission also affected.

It can be seen that biodegradable lubricants have a promising potential to be applied in the automobile application as an alternative lubricant as it offers multiple advantages such as excellent lubricity, high viscosity index, high flash points, biodegradable, less toxic and renewable also reduce dependency on imported petroleum oils. Many studies on biodegradable lubricants to prove its benefits and efficiency have been conducted. The present study should explore for more new resources or materials that have the potential to be processed into biodegradable lubricants. It should be widely and commercially implemented into the lubricant industry to ensure a better and greener future.

## Acknowledgement

The authors would like to thank the Ministry of Education Malaysia for supporting this research under Fundamental Research Grant Scheme (FRGS) Vot K218, K 224 and also Research Fund Universiti Tun Hussein Onn Malaysia (H802 and GPPS vot. U749).

## References

- [1] Bartz, W. J. (1998). Lubricants and the Environment. *Tribology International*, 31, 35-47.
- [2] Mohamad Nasir, M. H., Khalid, A., Darlis, N., Salleh, H., Sapit, A., Razali, M. A., & Radzali, M. H. (2021). Investigation of High Injection Pressure and High Ambient Pressure of Pyrolysis Oil Spray using Computational Fluid Dynamics. *Fuel, Mixture Formation and Combustion Process*, 4(1).
- [3] Mat Yasin, M. H., Salleh, M. R., Ali, M. H., & Mamat, R. (2022). Characterization of Physical Properties for Diesel-alcohol and Biodiesel-alcohol Blends. *Fuel, Mixture Formation and Combustion Process*, 4(1).
- [4] Zainal Abidin, S. F., Aziz, A. I., Md Noor, S. N., Jaat, N., Khalid, A., Asmawi, R., Sapit, A., & Mohammed, A. N. (2022). Effect of Oxygen Concentration and Homogeneous Charge Compression Ignition on Combustion Process and Exhaust Emissions. *Fuel, Mixture Formation and Combustion Process*, 4(1).
- [5] Loong, T.T., Salleh, H., Khalid, A., Koteh, H., "Thermal performance evaluation for different type of metal oxide water based nanofluids", (2021) *Case Studies in Thermal Engineering*, 27, art. no. 101288.
- [6] Salleh, H., Khalid, A., Sulaiman, S., Manshoor, B., Zaman, I., Amirnordin, S.H., Asyraf, A., Razzaly, W., "Effects of fluid flow characteristics and heat transfer of integrated impingement cooling structure for micro gas turbine", (2020) *CFD Letters*, 12 (9), pp. 104-115
- [7] Manshoor, B., Sapit, A., Nordin, N., Hariri, A., Salleh, H., Razali, M.A., Zaman, I., Khalid, A., Ghazali, M.F., Alsayed, M.K., "Simulation of fractal like branching microchannel network on rectangular heat sink for single phase flow", (2020) *CFD Letters*, 12 (2), pp. 69-79.
- [8] Sapit, A.B., Razali, M.A.B., Mohammed, A.N.B., Manshoor, B.B., Khalid, A.B., Salleh, H.B., Hushim, M.F.B., "Study on Mist Nozzle Spray characteristics for cooling application", (2019) *International Journal of Integrated Engineering*, 11 (3), pp. 299-303.
- [9] Amirnordin, S.H., Khalid, A., Zailan, M.F., Fawzi, M., Salleh, H., Zaman, I., "Thermal Imaging of Flame in Air-assisted Atomizer for Burner System", (2017) *IOP Conference Series: Materials Science and Engineering*, 226 (1), art. no. 012008,
- [10] Mohd Nizam, M. A., & Salleh, H. (2019). Hydrodynamic and Thermal Characteristics Study of Heat Exchanger for Micro Gas Turbine Application. *Fuel, Mixture Formation and Combustion Process*, 1(2).
- [11] Panchal, T. M., Patel, A., Chauhan, D., Thomas, M., & Patel, J. V. (2017). A methodological review on biolubricants from vegetable oil based resources. *Renewable and Sustainable Energy Reviews*, 70, 65-70. doi: 10.1016/j.rser.2016.11.105



- [12] Maleque, M., Masjuki, H., & Sapuan, S. (2003). Vegetable - based biodegradable lubricating oil additives. *Industrial Lubrication and Tribology*, 55(3), 137-143. doi:10.1108/00368790310470976
- [13] Zulkifli, N., Kalam, M., Masjuki, H., Shahabuddin, M., & Yunus, R. (2013). Wear prevention characteristics of a palm oil-based TMP (trimethylolpropane) ester as an engine lubricant. *Energy*, 54, 167-173. doi: 10.1016/j.energy.2013.01.038
- [14] Ramesh, D., & Balusamy, T. (2017). Investigation on Four Stroke Petrol Engine Lubrication with Blends of Pongamia Oil and Mineral Oil. *International Journal of Recent Trends in Engineering & Research (IJRTER)*, 3(01), 150-158.
- [15] Mobarak, H., Mohamad, E. N., Masjuki, H., Kalam, M., Mahmud, K. A., Habibullah, M., & Ashraful, A. (2014). The prospects of biolubricants as alternatives in automotive applications. *Renewable and Sustainable Energy Reviews*, 33, 34-43. doi: 10.1016/j.rser.2014.01.062
- [16] Luna, F. M., Cavalcante, J. B., Silva, F. O., & Cavalcante, C. L. (2015). Studies on biodegradability of bio-based lubricants. *Tribology International*, 92, 301-306. doi: 10.1016/j.triboint.2015.07.007
- [17] Zulkifli, N., Azman, S., Kalam, M., Masjuki, H., Yunus, R., & Gulzar, M. (2016). Lubricity of bio-based lubricant derived from different chemically modified fatty acid methyl ester. *Tribology International*, 93, 555-562. Doi: 10.1016/j.triboint.2015.03.024
- [18] Venkatesan, C., Vignesh, K., Kannadasen, P., & Ramasivam, G. (2014). Rapeseed Oil based Lubricant Reduces Smoke Emission in Two-Stroke Petrol Engine. *International Journal of Engineering Technology, Management and Applied Sciences*, 2(4), 168-179.
- [19] Nirmal, V. P., & Dineshbabu, D. (2015). Performance and Emission of Pongamia Pinnata Oil as a Lubricant in Diesel Engine. *International Journal of Innovative Research in Science, Engineering and Technology*, 4(2), 435-441.
- [20] Ashwini, S., Bharati, S., Gajanan, K., & Tushar, S. (2016). Heart Oil Used as Bio Lubricant in Diesel Engine. *International Advanced Research Journal in Science, Engineering and Technology (IARJSET)*, 3(4), 174-176.
- [21] Masjuki, H., Maleque, M., Kubo, A., & Nonaka, T. (1999). Palm oil and mineral oil based lubricants—their tribological and emission performance. *Tribology International*, 32(6), 305-314. doi:10.1016/s0301-679x(99)00052-3
- [22] Mannekote, J. K., & Kailas, S. V. (2011). Experimental Investigation of Coconut and Palm Oils as Lubricants in Four-Stroke Engine. *Tribology Online*, 6(1), 76-82. doi:10.2474/trol.6.76
- [23] Boopathi, D., Parthiban, P., Palanivendhan, M., & Devanand, S. (2016). Experimental Investigation on Effect of Vegetable Oil based Lubricant for Diesel Engine. *Indian Journal of Science and Technology*, 9(29). doi:10.17485/ijst/2016/v9i29/96535
- [24] Sharma, C., Sundar, G. S., Harish, B. K., Sitale, S. M., & Smitha, S. B. (2017). Experimental Study on The Use of Neem Oil as Lubricant in IC Engine. *International Research Journal of Engineering and Technology (IRJET)*, 4(8), 1087-1092.
- [25] H., Kaushik, A., D, J. K., & B, C. R. (2017). Comparative Study of Performance and Emission Characteristics of Four Stroke S.I. Engine Under Various Bio Lubricants.
- [26] De Almeida, S. C., Belchior, C. R., Nascimento, M. V., Vieira, L. D., & Fleury, G. (2003). Performance of A Diesel Generator Fuelled with Palm Oil. *Fuel and Energy Abstracts*, 44(3), 2097-2102. doi:10.1016/s0140-6701(03)81906-9
- [27] Reddy, K. S., Kabra, N., Kunchum, U., & Vijayakumar, T. (2014). Experimental Investigation on Usage of Palm Oil as a Lubricant to Substitute Mineral Oil in CI Engines. *Chinese Journal of Engineering*, 2014, 1-5. doi:10.1155/2014/643521