



Development of First Aid Kit with Intuitive Touch Screen Display and Voice Instruction

Nor Fara Syahira Mahpar¹, Nur Anida Jumadi^{1,2*}

¹Department of Electronic Engineering, Faculty of Electrical and Electronic Engineering, Universiti Tun Hussein Onn Malaysia, Batu Pahat, 86400, MALAYSIA

²MiNT-SRC, Institute for Integrated Engineering, Universiti Tun Hussein Onn Malaysia, Batu Pahat, 86400, MALAYSIA

*Corresponding Author

DOI: <https://doi.org/10.30880/jeva.2021.02.01.001>

Received 16 February 2021; Accepted 21 March 2021; Available online 30 June 2021

Abstract: First aid kit has been used to treat minor pain or injuries before one can receive a qualified treatment from the medical doctor. It is found that the contents inside the first aid is only checked periodically and as a result, there is high chance that certain important medicine is not there by the time it is needed. Thus, the development of smart first aid kit that prioritizes on content management via intuitive display and voice instruction is presented in this paper. The developed smart first aid kit offers several unique features. The first is the use of infrared sensor to detect the availability of the first aid content. If the content is taken, the red LED will be lit up, and the user is notified through Blynk apps in smartphone and email by means of NodeMCU. The second feature is that the developed first aid is equipped with the Smart TFT LCD touch screen display and speaker. This smart touch screen can display the list of first aid contents as well as provide a quick button for voice instructions. The voice instruction button will play the recorded guidance and medical instructions in the form of phrases and voices. The programming for the touch screen display, the voice instructions (played by Arduino Mini MP3 module) and speaker are all processed by the Arduino Mega. Simple testing and analysis on sensor detection and notification revealed that both sensor and Blynk app work fine if the medications are placed in the correct position. In conclusion, a smart first aid kit with touch screen medications instructions menu equipped with voice instructions and the ability to alert the end user whenever the content of first aid is taken out has been successfully developed and executed in this study. All sensors and the programming for the touch screen and voice instruction work accordingly. For future work, several improvements are recommended such as better data management that has complete record on date, time, and name of the content that is taken out as well as alerting the user on the expiry date. This can help the person in charge to efficiently monitor the content in the first aid.

Keywords: First Aid Kit, infrared sensor, Blynk app, TFT LCD Touch Screen, Arduino Mega, NodeMCU

1. Introduction

First aid kits have been used widely by worldwide community and have been extensively used to treat patients with pain or minor injuries before receiving qualified treatment. An injury is an organic body lesion arising from acute energy (mechanical, kinetic, electrical, chemical or radiant) exposure in concentrations that exceed the physiological tolerance threshold [1]. This life-saving tool or first aid is an assessment and intervention that can be carried out at once by a person with limited or no medical equipment nearby [2]. In fact, the first aid kit should be readily available either at home or working place as unexpected injury might happen anytime. Usually, all of medication equipment that are stored in the

first aid kit has been standardized except for a large kit which held added accessories. Common contents that can be found in the first aid kit are emergency handbook, gauze wrap sterile, cotton, adhesive tape, fabric wraps of all sizes, antiseptic fluid, scissors, safety pins, plastic gloves and a list of emergency phone numbers [3].

It is worth to mention here that there are content differences between the faculty’s laboratory first aid kit compared to pharmacies and drugstores first aid kit. In view of that fact, Pusat Kesihatan Universiti (PKU), UTHM has setup a guideline on contents that must be stored in the faculty laboratory’s first aid kit. Such pre-determined contents are gauze, triangular bandage, elastic bandage, micropore tape, plasters, bacidin cream, and methyl salicylate gel. These seven items are in fact, can be categorized as non-swallowable medicines since the common accidents that occurred in the laboratory are mainly involve with external injuries. A personal observation had been conducted on the listed medications and accessories available in the faculty’s laboratory first aid. Although the items in the laboratory’s first aid kit fulfill the predetermined contents as suggested by PKU, UTHM, it was found that these non-swallowable medicines were placed together in the same partition or in other words, it only has one partition to store all items. Besides that, monitoring of the availability of the first aid contents is only done periodically. As a result, there is a high chance that certain important medicines are not there by the time it is needed. There are several earlier projects related to first aid kit [4-7] and such example to be cited here was about the use of a drone to carry the first aid kit for sports activities [8]. However, similar with the issue in the first aid kit in the laboratory, this previous project did not emphasize further on the content management of first aid kit.

For that reason, this project is proposed with the main aim to develop the first aid kit prioritizes on the content management via intuitive display and voice instruction. Main components employed in this project are Arduino Mega2560 and NodeMCU microcontrollers, touch screen display, Infrared sensors, Light Emitting Diode (LED) indicator and Arduino Mini MP3 module. The infrared sensor is being considered in this study because of its cheap price, it can be easily programmed in Arduino using digital pins and is usually used for demonstrating detection of items. Three objectives are being set which is first; to construct the main circuits for touch screen display, mp3 module and detection of first aid content, second; to program codes for touch screen medication instructions menu with voice instructions and notify the end user whenever the content of first aid is taken out and finally; to design and develop the first aid partition and case according to the needs in the laboratory. A few scopes of project to be highlighted are only first aid kit in the faculty’s laboratories is being considered, the first aid’s contents are based on the PKU guidelines (only 7 non-swallowable medicines) and the prototype is developed using acrylic.

2. Materials and Methods

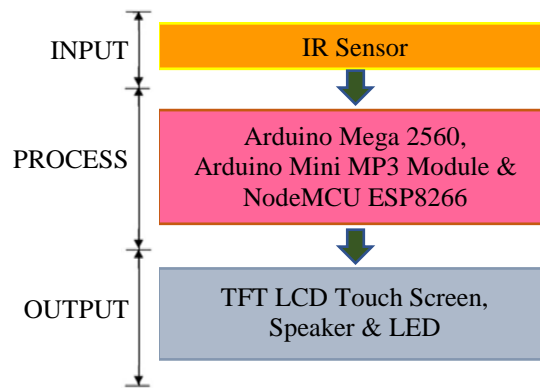

Fig 1 - Block diagram for developed prototype of first aid kit

The block functional diagram is shown in Figure 1. It consists of three main stages: input, process and output. The input consists of the only sensor device used in this project which is infrared sensor to detect the contents in the first aid kit. The process stage involves the use of two microcontrollers: Arduino Mega and NodeMCU ESP8266. The NodeMCU is used to program detection when the content is taken out (via Infrared sensor) and signal the missing of content through LED and Blynk. Meanwhile, the Arduino Mega is programmed to display the headline or start-up screen, content list as well as written instructions. Meanwhile, the voice instructions (in the form of mp3 or wav files) must be inserted into the SD card before it can be played by Arduino Mini MP3 (which is connected to Arduino Mega). The output stage for first aid is the TFT Liquid Crystal Display (LCD) touch screen display, speaker, LED, as well as user notification via Blynk app and email. The touch screen comes with a capacitive touch screen attached to it, so it can detect finger or stylus pen when pressed on the screen.

2.1 Schematic Diagram

Figure 2(a) shows the schematic diagram of Arduino Mega, TFT LCD touch screen, Arduino Mini MP3 Module and speaker. The connection between the touch screen and Arduino Mega can be connected directly by inserting the pin of microcontroller into the interface without wire. The mapping pins between the touch screen and the microcontroller are CS pin > A3 pin, CD pin > A2 pin, WR pin > A1, RD pin > A0 and RESET > A4. Meanwhile, Figure 2(b) represents the schematic diagram of NodeMCU ESP8266, infrared sensor and LED indicator. This circuit functions as to detect the content availability and sending the notifications to smartphone and email via Blynk apps. The LED is defined as output and is programmed to turn on if any contents in the first aid is taken out. Meanwhile, the seven infrared sensors are defined as inputs pins and are programmed to detect seven non-swallowable items.

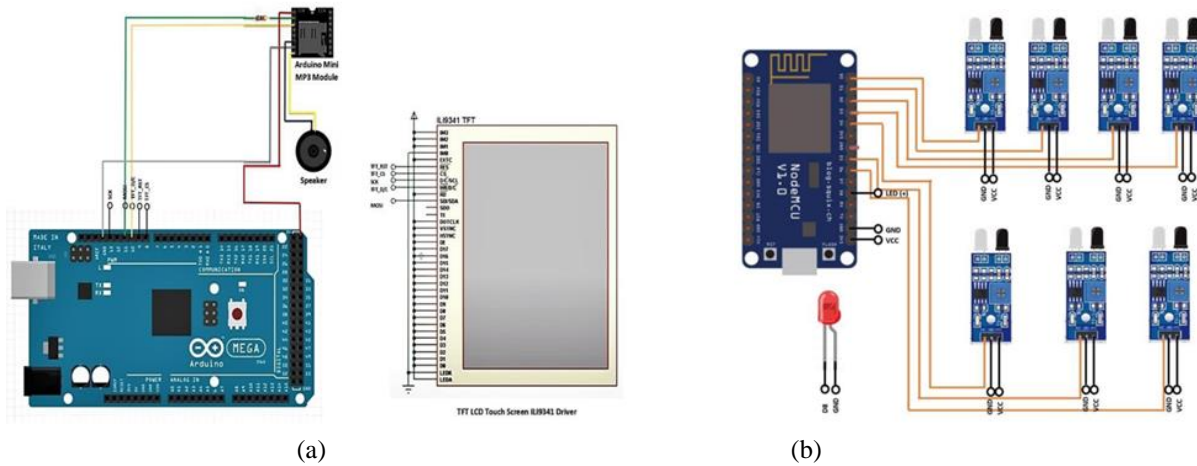

Fig 2 - Schematic diagrams for (a) Arduino Mega, TFT LCD Touch Screen, Arduino Mini MP3 Module and speaker; (b) NodeMCU ESP8266, infrared sensor and LED indicator

2.2 Flow Chart and Programming Codes

Figure 3(a) and (b) show the flow chart of the touch screen and the detection of the content, respectively. There are two designed modes; first mode (Figure 3(a)) is for displaying the contents and produce voice instructions and the second mode (Figure 3(b)) is to alert the end user whenever the content of first aid is taken out. With the TFT LCD touch screen, user can select and read the listed contents and instructions or can hear the voice instructions by pressing the voice button. Meanwhile, there are also two modes of notification to notify the user if the current contents are taken out from the first aid. First is from the prototype itself by means of LED indicator and the second is from the smartphone and email. When the medicines are inside the developed first aid, the LED will be OFF. Otherwise, the LED will be ON indicating the medicine is taken out. Secondly, the same notification from smartphone which is linked to the Blynk app will be sent out to the registered email of the person in charge.

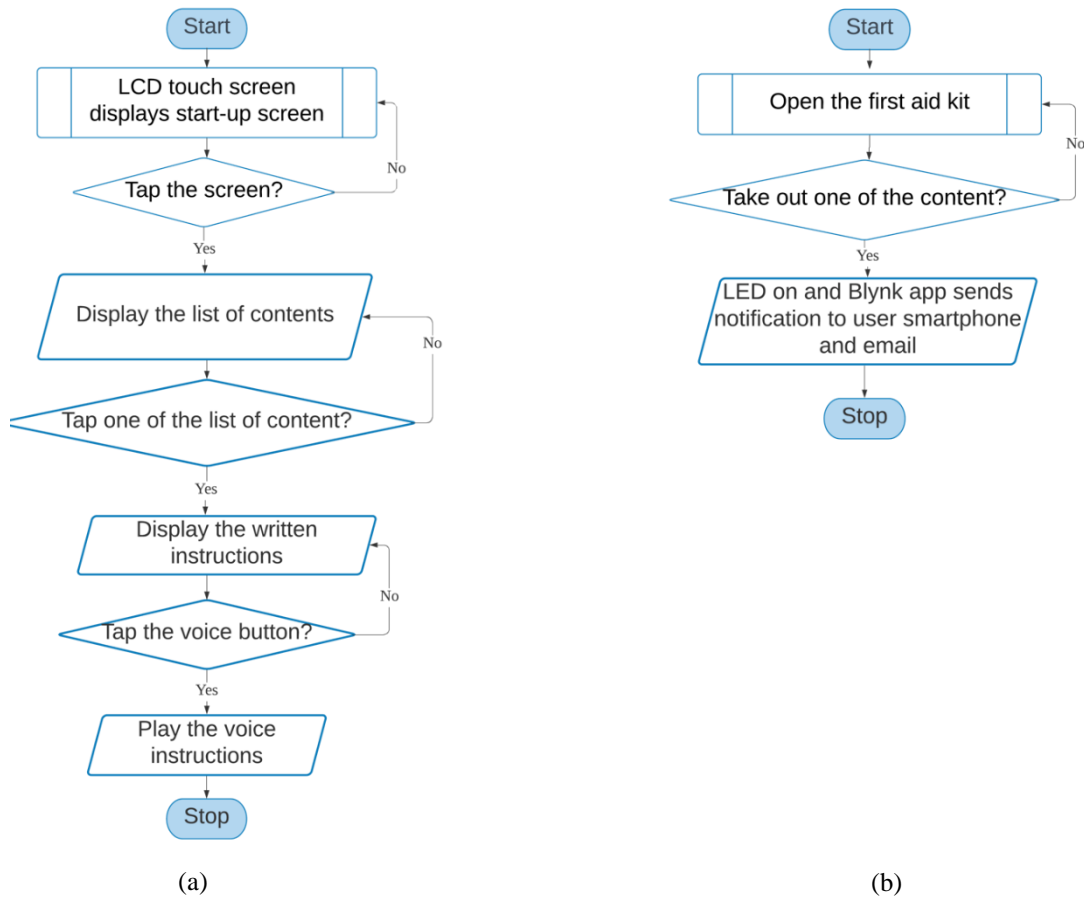

Fig 3 - (a) Flow chart of TFT LCD touch screen; (b) Flow chart of detection when the content is taken out from the first aid

There are several important programming codes that will be highlighted in this section. First to be discussed is the codes to program the touch screen display. Two important libraries are used namely as Elegoo GFX and Elegoo TFTLCD. Figure 4 shows the coding used to set the screen and display text. The `tft.reset()`, `tft.fillScreen(RED)` and `tft.setRotation(1)` are used to reset the screen, color the screen in red and set the screen into the landscape mode, respectively. The code `tft.drawRect(10,10, 300,215, WHITE)` is used to set a white rectangle with curved corners to be as the border of the screen. Meanwhile, `tft.setCursor(70,60)`, `tft.setTextColor(WHITE)`, `tft.setTextSize(2)` are employed to set the position of headline/start-up screen, set the text in white and set the text size, respectively. The default size is '1' and each change in size increases the text by 10 pixels in height. That is to say, size 1 corresponding to 10 pixels, size 2 is 20 pixels and so on. Since the TFT LCD touch screen has 240 x 320 8-bit color pixels, thus the maximum text size for the first aid display is 2. Finally, `tft.print("SMART FIRST AID")` is used to display the text.

```

168 //LCD DISPLAY
169 tft.begin(0x9341);
170 tft.setRotation(1);
171 tft.fillScreen(RED);
172
173 //Draw white frame
174 tft.drawRect(10,10,300,215,WHITE);
175
176 //Print "SMART FIRST AID" Text
177 tft.setCursor(70,60);
178 tft.setTextColor(WHITE);
179 tft.setTextSize(2);
180 tft.print("SMART FIRST AID");
    
```

Fig. 4 - Functions used to program touch screen display

Meanwhile, programming codes used to program the infrared sensors and LED indicator for items detection and notification is shown in Figure 5. In order to ensure that the NodeMCU can be used, two libraries must be included in the beginning of the programming which are ESP8266WiFi and BlynkSimpleESP8266. Figure 5(a) shows the declaration of the digital input and output pins to program seven infrared sensor and an LED. Meanwhile, programming codes to light up the LED indicator as well as Blynk notification are done by using if-else statement as depicted in Figure 5(b). When the digital input is in logic High (indicates that the item is being taken out), the LED which is programmed to be as an output is set to be logic High by using digitalWrite() syntax. At the same time, the alert notification is sent to Blynk apps by using the Blynk.notify() syntax.

<pre> 26 void setup() 27 { 28 Serial.begin(9600); 29 pinMode(IR1,INPUT); 30 pinMode(IR2,INPUT); 31 pinMode(IR3,INPUT); 32 pinMode(IR4,INPUT); 33 pinMode(IR5,INPUT); 34 pinMode(IR6,INPUT); 35 pinMode(IR7,INPUT); 36 pinMode(LED,OUTPUT); 37 Blynk.begin(auth, ssid, pass); 38 } </pre> <p style="text-align: center;">(a)</p>	<pre> 50 if (Status1 == HIGH){ 51 digitalWrite(LED,HIGH); 52 Blynk.notify("Alert : Gauze has been taken out"); 53 flag=1; 54 } 55 else if (Status2 == HIGH){ 56 digitalWrite(LED,HIGH); 57 Blynk.notify("Alert : Swab has been taken out"); 58 flag=1; 59 } 60 else if (Status3 == HIGH){ 61 digitalWrite(LED,HIGH); 62 Blynk.notify("Alert : Triangular Bandage has been taken out"); 63 flag=1; 64 } </pre> <p style="text-align: center;">(b)</p>
---	--

Fig. 5 - Programming codes to: (a) set digital pins as input and output; (b) set LED output status and Blynk notification when the digital input pin is high

2.3 3D Case Design for First Aid

Figure 6 shows the 3D case design for first aid prototype developed by using SketchUp software. The dimension (length x width x height) is 38 cm x 31 cm x 10 cm. Figure 6(a) illustrates the front view design of the prototype in which the arrangement of the touch screen, LED indicator and speaker (place underneath the small holes) are placed near to each other. Then, Figure 6(b) shows the six partitions or compartments to place the seven non-swallowable medicines according to the suggestion by PKU, UTHM. Meanwhile, the small rectangle at each of the compartment represents the position of the infrared sensor in each partition.

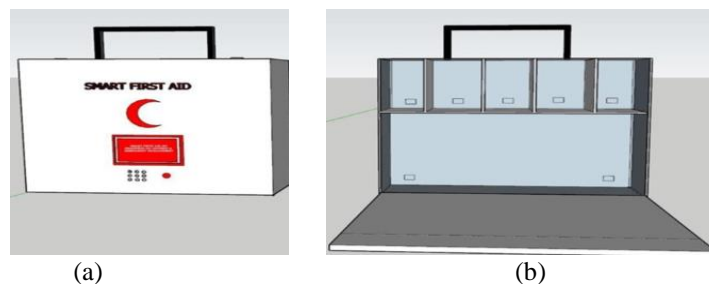

Fig. 6 - Sketchup 3D design of first aid prototype from the (a) front view; (b) compartment view

3. Results and Discussion

The main findings are presented in this section that cover the resulted prototype of first aid kit and followed by the testing and evaluation of the prototype.

3.1 Final Prototype of First Aid Kit

Figure 7 shows the final prototype of the first aid kit together with its main components. The case of first aid kit was developed from acrylic and was sprayed white. As can be seen from Figure 7(a), label 1, label 2 and label 3 are TFT LCD touch screen display, speaker and LED indicator, respectively. This is following the proposed design using Sketchup software as described in the earlier section. The list of contents in the first aid and the written instructions will be displayed when the user touches the LCD touch screen. Meanwhile, the voice instructions will be heard loud from the speaker each time the user presses the voice button, and the LED indicator will light up as a signal that the first aid does not have enough medication or accessory. Next, Figure 7(b) shows the image of circuit connection between Arduino Mega (label 4) and Arduino Mini MP3 Module (label 5) during troubleshooting process. The coding of the voice instructions was uploaded into the Arduino Mega and the Arduino Mini MP3 played the voice instructions of contents in the first aid.

Then, Figure 7(c) shows the six compartments to place medicines and related accessories based on suggested contents by PKU, UTHM. Notice that there were also seven infrared sensors that were attached at each of the compartment which were used to detect the contents availability. So long that the sensor detects the content, the digital sensor will output low. The infrared sensors were connected to NodeMCU which was placed right beneath the compartment (not shown in the image). It should be mentioned here, although the biggest compartment (refer to Figure 7(c)) can store more than two medications, the reason two infrared sensors are utilised is because to follow the guidelines set-up by the PKU, UTHM (only seven non-swallowable medicines) as previously mentioned in the scopes of study. Also, to avoid different items being mixed up, the infrared sensors are placed at the corner end of the compartment. Nevertheless, this issue becomes the limitation to the prototype case design. Thus, the compartment is suggested to be redesigned in the future to suit with the real dimension of the contents. Since seven infrareds are required to detect the seven items, this has caused the increasing number of wires used at once. Thus, another possible solution that can be considered in the future is by using a simple on-off circuit. Finally, Figure 7(d) shows the image view of the wiring connection between Arduino Mega, TFT LCD Touch Screen and speaker. The position of this circuit is located at the back of the prototype's main door. This prototype first aid used power bank to supply currents to all its circuit components.

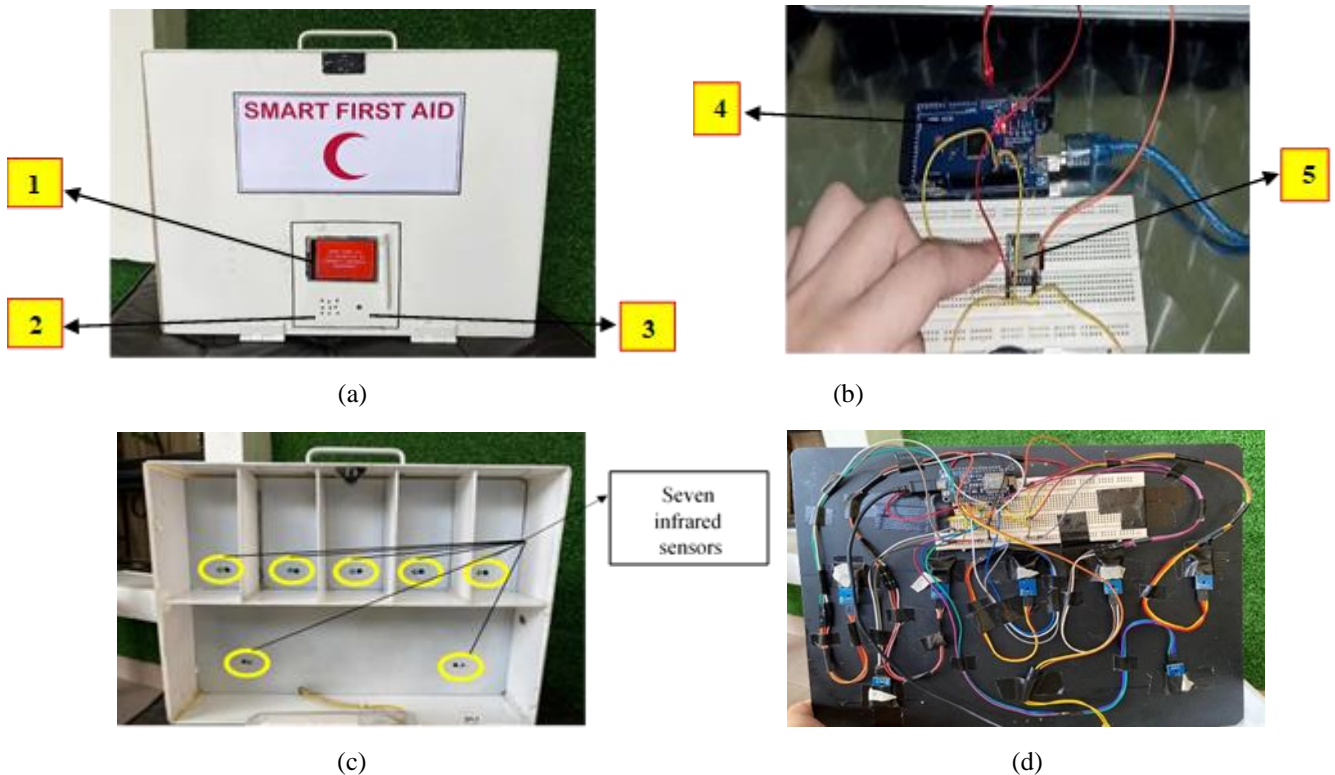

Fig 7 - (a) Front view of developed first aid; (b) Connection between Arduino Mega and Arduino Mini MP3; (c) Compartments inside prototype and the infrared sensors; (d) Image of wiring connection between Arduino Mega, TFT LCD Touch Screen and speaker

3.2 Testing and Evaluation

3.2.1 Functionality testing of prototype's touch screen display, sensors and user notification

a) Power-up Testing

- i. When the device was turned on, the TFT LCD touch screen was able to display start-up screen as shown in Figure 8.
- ii. The TFT LCD touch screen comes with a pen so it makes much easier for the user to touch the screen effectively.



Fig 8 - Start-up screen after power-up device

b) Page Tab Screen Testing

- i. When touched or tapped on the surface of TFT LCD touch screen, the display was able to show the list of contents in the first aid as shown in Figure 9. For the first page tab, it successfully displayed the list of contents numbered from 1 to 4 while the page listed contents numbered from 5 to 7 was shown after hitting the ‘More...’ button.



Fig 9 - Display the list of contents

c) Displaying Written Instructions and Playing Voice Instructions Testing

- i. The display was able to show instructions in sentences (Figure 10(a)) on how to use medication or accessory when the list of the contents was selected. Other than that, when the ‘Voice’ button was pressed (Figure 10(b)), the instructions through voice was successfully playing.



Fig 10 - (a) Touch screen displays the instruction; (b) Voice button

d) Infrared Sensors Testing

- i. Figure 11 shows that the LED was successfully turned on (Figure 11(b)) to indicate that the user had taken out one of the contents which was bandage (Figure 11(a))



(a)



(b)

Fig 11: (a) User took out one of the contents (bandage) in first aid; (b) LED was lit up

e) Alert Notifications Testing

- i. Figure 12(a) and 12(b) showed the successful notifications being sent out from the Blynk Apps to the smartphone and email stated that the bandage had been taken out from the first aid.

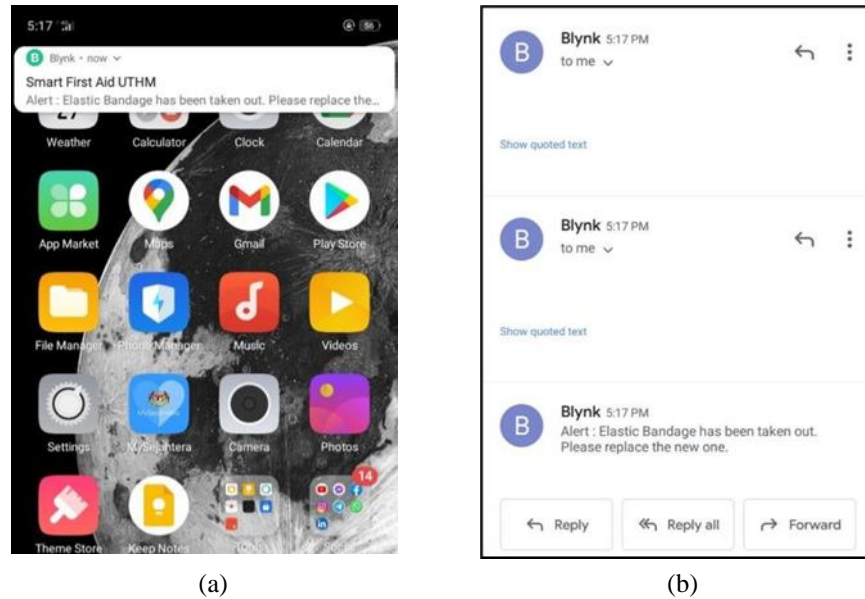

Fig 12 - The alert notifications from the Blynk app to (a) smartphone, (b) Gmail inbox







3.2.2 Analysis on Detection and Notification

Table 1 listed out seven medication and accessories as recommended by PKU, UTHM which consist of gauze, micropore tape, triangular bandage, elastic bandage, plasters, bacidin cream and methyl salicylate gel. As can be seen from Table 1, the analysis shows that when the medication or accessory was in the correct position, the infrared could detect motion of taking out resulting the lights on by the LED indicator while the Blynk app successfully sent out the alert and email notification as was foreseeable. Meanwhile, the analysis on detection when medication was placed at different positions is shown in Table 2. As could be expected, the findings revealed that the LED indicator kept lights on since the sensors detect the content was missing. Thus, this has become the limitation of this current prototype since the sensor is placed at one fix position only. This prototype can function very well as long that the content is placed at the right position. Therefore, it is suggested that a study on deciding suitable sensor position can be conducted in the future to overcome this limitation.

Table 1 - Analysis on detection and notification when the content was taken out when it was placed at the right position

No	Name of medication or accessory	When medication or accessory is taken out			
		IR detects?	LED lights on?	Notification on smartphone?	Notification in email?
(i)	Gauze	Yes	Yes	Yes	Yes
(ii)	Micropore tape	Yes	Yes	Yes	Yes
(iii)	Triangular bandage	Yes	Yes	Yes	Yes
(iv)	Elastic bandage	Yes	Yes	Yes	Yes
(v)	Plasters	Yes	Yes	Yes	Yes
(vi)	Bacidin cream	Yes	Yes	Yes	Yes
(vii)	Methyl salicylate gel	Yes	Yes	Yes	Yes

Table 2 - Analysis on detection when the content was placed at different positions (not above the infrared sensor)

No.	Name of medication	Different position	LED lights on?	No.	Name of medication	Different position	LED lights on?
(i)	Gauze		Yes	(v)	Plasters		Yes
(ii)	Micropore tape		Yes	(vi)	Bacidin cream		Yes
(iii)	Triangular bandage		Yes	(vii)	Methyl salicylate gel		Yes
(iv)	Elastic bandage		Yes				

4. Conclusion

In conclusion, all objectives that were set in the beginning of the research were successfully achieved. The developed first aid kit has several unique features such as it is equipped with intuitive touch screen to display medications instructions menu as well as voice instructions. Besides that, it can alert the user via LED indicator and able to send notifications to smartphone and email whenever the content in the first aid is taken out. As for future recommendations, a study on deciding suitable sensor position can be conducted in the future to overcome limitation caused by one fix infrared sensor position. Regarding the first aid case, the compartment can be redesigned to suit with the size of the medicines whereas a proper casing can be made to protect the infrared sensor. Besides that, using the programming and advantages in Blynk notification, an expiry notification can be sent to alert the end user for immediate action on items replacement. Alternatively, a sound notification system can be implemented to keep beeping in suitable interval time so that the user will be kept reminded on replacing the items. Other than that, a better data management can be proposed for instance, by developing a database system that is able to keep the record of the date, time, and name of the content when it is taken out as well as expiry date for each content. This can help the person in charge to monitor and organize medications or accessory of the first aid efficiently.

Acknowledgement

The authors would also like to extend deepest gratitude to RMC (Research Management Centre) for providing supplementary funding under TIER1 grant (H226) and to the Faculty of Electrical and Electronic Engineering, Universiti Tun Hussein Onn Malaysia for the technical and continuous moral support.

References

- [1] E. G. Krug, G. K. Sharma, and R. Lozano, "The global burden of injuries," *Am. J. Public Health*, vol. 90, no. 4, pp. 523–526, 2000
- [2] S. Kumar, D. Kulkarni, P. Srinivas, N. Prakash, B. Hugara, and S. Ashok, "Perception And Practices Regarding First-Aid Among School Teachers In Mysore," *Natl. J. Community Med.*, vol. 4, no. 2, pp. 349–352, 2013
- [3] Kevin Druley, "First aid kit requirements." 2019, [Online]. Available: <https://www.safetyandhealthmagazine.com/articles/19019-first-aid-requirements>
- [4] A. Pramono, "First aid instructional media using android platform", 2017 4th Int. Conf. Computer. Appl. Inf. Process. Technol., pp. 3-7, 2018
- [5] A. Lucchetti, M. Tanelli, S. M. Savaresi, and M. Santucci, "Design of rapid first- aid alert systems for 2-wheeled vehicles via smartphones' inertial sensors," *IFAC- PapersOnLine*, vol. 49, no. 11, pp. 541–546, 2016.
- [6] J. G. Kurebwa and T. Mushiri, "Internet of things architecture for a smart passenger-car robotic first aid system," *Procedia Manuf.*, vol. 35, pp. 27–34, 2019
- [7] V. Vijayashangavi, M. M., U. M., F. M., and S. G., "Smart Health Care System- An Easy First Aid Solution," *Int. J. Comput. Appl.*, vol. 180, no. 4, pp. 19–24, 2017
- [8] G. C. Bravo, D. M. Parra, L. Mendes, and A. M. De Jesus Pereira, "First aid drone for outdoor sports activities," *TISHW 2016 - 1st Int. Conf. Technol. Innov. Sport. Heal. Wellbeing, Proc.*, no.1, 2016