

Home Monitoring System by Using Iot

Abdalla Hassan Abakar Eisa¹, Radiah Mohamad^{1*},

Faculty of Computer Science and Information Technology,
Universiti Tun Hussein Onn Malaysia, Parit Raja, Batu Pahat, 86400, MALAYSIA

DOI: <https://doi.org/10.30880/aitcs.2023.04.02.037>

Received 19 January 2023; Accepted 14 June 2023; Available online 30 November 2023

Abstract: Technology is a massive and rapidly expanding process. Home monitoring systems that use IoT are becoming increasingly popular among academics and developers in the modern era. This is related to human nature's desire for a comfortable living. One of the most crucial parts of making life comfortable and feeling secure and peaceful is safety. This project is being developed to assist humans in achieving this feeling. In this home surveillance system, Raspberry Pi is used to integrate sensors, camera, and networks. It applies the concept Internet of Things (IoT) in its system. The main purpose of this project is to observe home more easily and ensure the safety of life and property. In this system, a camera is used to identify intruder outside the home.

Keywords: *Home, IoT, Security, Monitoring.*

1. Introduction

There is no place like home, is a famous quote which is refer to the significance of our homes and shows the truth of this statement. A well-designed home monitor system is needed for any country's growth. It is possible to describe a home monitoring system as the process by home monitoring is funded, coordinated and distributed to a population. This includes access issues (for whom and to which services), spending, and funding [1].

The goal of a home monitoring system is to improve house technology in a best manner among the people in this world to help the community to develop house controlling through Internet of Things (IoT). And get the ability to control. Smart phone, laptop, tablet and desktop applications or websites are the tool being used in the latest typical home monitoring systems. Using these methods, a house owner has to control the house using the application/website with help of integrated circuits and IoT will be able to figure out what is happening in the house and to control it approach. In addition, in order to avoid robbers, thieves and intruders, the security aspect of the home monitoring system is essential. Furthermore, security and safety are provided along with the system, which is a perfect solution towards people with weak faith to tend stealing from houses. [2].



Figure 1: Prototype of Smart Home [1].

2. Related Work

The implementation of project components should be low-cost in terms of money for the proposed home monitoring system to be designated. In this instance, the product will be more economically accessible. Thus, the project designation features should be functional and long-lasting, as this will increase the product's reliability for users. The suggested project should include a variety of types of features that a basic smart house should provide. This also improves the product's compatibility with other projects. The proposed project's IoT hardware and software execution, in particular, necessitated testing and knowledge of the design of a mobile framework. Hardware such as a humidity and temperature sensor (DFR0067), a servo motor, and other components are required to understand how the system works and the architecture and characteristics of the component. In addition, the software required the Raspberry Pi and Red Node for hardware and software construction. A real-time database from the red node was also used for real-time data transmission and storage inside the website, as well as hardware functionality.

After all, there are features were planned for the proposed project, which are automated door lock, speaker, surveillance camera and indoor temperature and humidity monitoring. The automated door lock of the project is designed based on the idea from home automation system [3]. The automated door lock is proposed by the project, which provide user to have an automated door lock for the front door of their house with a lower price. For the indoor temperature and humidity monitoring, user is allowed to visualize the value of the room temperature and relative humidity inside their house by the notification panel from the Android app provided by referring Smart House [4]. For the surveillance camera, which feature is implemented for the proposed project based on AI home automation system [5]. The feature of surveillance camera, which allow user to observe the outdoor environment of their house by using the proposed website.

[6] In the wireless telecommunications field, the Internet of Things (IoT) is a new model that is currently gaining awareness and adoption. The Internet of Things (IoT) is a model in which the central premise is to connect gadgets and items such as sensors, screens, automobiles, and home appliances to

people via a uniform structure. These devices may be able to communicate with one another in order to complete a shared mission. The Internet of Things has spurred the development of many apps that can leverage a vast amount and variety of data to benefit communities by enabling accessibility and connectivity between a variety of different devices. The Internet of Things (IoT) is a network of "things" that are connected to a common network path to communicate, exchange information, and regulate each other. Home automation, computer-integrated manufacturing, agriculture, medical applications, elderly assistance, and automobile enhancement are just a few of the many industries where IoT offers new opportunities for growth. Any embedded software, hardware, or any sensor containing "things" could be integrated or interconnected to the network path. This refers to a condition in which "things" will have an increasing amount of linked data and details. Furthermore, the IoT is capable of uploading and producing new data, as well as being a vital component of the internet. It includes not only internet access, but also cloud and information storage, data and security management, and all other aspects of the internet era [7].

2.1 Summary of comparison

Table 1 shows the summary of comparison of existing system.

Table 1: comparison of existing system

No	Title	Approach	Table of development	Database server	Programming language required
1	Home automation system using ESP8266	Windows based	Arduino IDE	HTTP server	C programming of Arduino IDE
2	Senior Design IOT: Smart House	Linux OS based	Raspberry Pi	HTTP server	JavaScript Programming, Python for Raspberry Pi
3	IoT Based Home Automation Using Raspberry Pi	Windows/Linux based	Raspberry Pi	HTTP server	PHP Programming, Python for Raspberry Pi
4	Home Automation System	LAMP Linux OS based	Zigbee or Z-Wave protocol, HTTPS and TLS protocols, and Android ADT	Apache server, MySQL database	PHP Programming, C Programming of Arduino IDE, JavaScript Object Notation from Python Library

Table 1: (cont)

5	Home Automation system using IoT	Debian Linux OS based	Arduino IDE and Microsoft Visual Studio 2010	MySQL and SQLyog database	C Programming of Arduino IDE and Java Programming Language
6	Arduino based smart home automation system	Windows based	Arduino UDE	HTTP server	C Programming of Arduino IDE

3. Methodology/Framework

This chapter describes the project structure and design phase of the planned home monitoring system. Additionally, details will also be given on the hardware and cloud systems utilized and how they function.

In addition, this chapter contains and discusses the core concept of how the framework is applied. Block diagrams is often presented to give a better understanding of how the entire project will be operate

3.1 Project Phases

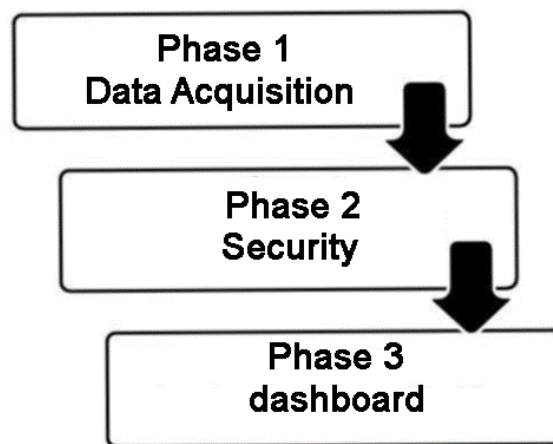

Figure 2: the phases

The project is designed to keep an eye on the house and discover any unusual measurements that could pose a threat. The sensor monitors the temperature and humidity and displays it on the dashboard in the first step, Data Acquisition.

Security's second phase has begun. It determines whether there is a risk at home by detecting if someone is present via camera, then launches a random scenario and sends an HTTP request.

The collected data will be shown on the dashboard in Phase 3 and an email will be sent to the home's owner if an abnormal process occurs.

3.2 Block Diagram

Block diagram of the proposed design is shown in Figure 3. It shows all the elements were used in the project and their connections.

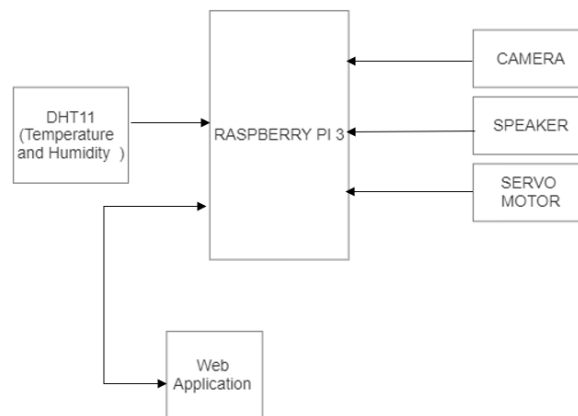

Figure 3: Block Diagram of the system

The temperature and humidity sensor (DHT11) are connected to the Raspberry Pi 3 as inputs to measure the temperature and humidity of the dwelling area, as illustrated in Figure 3. A camera is attached to the Raspberry Pi 3 to detect whether somebody is near the house, a speaker is connected to make sounds, and servo motor to shake the door. A Wi-Fi module on the Raspberry Pi is used to deliver HTTP requests to the flask application. The parameters collected from the sensor are read by the system. The information is also provided to the online application.

3.3 System Requirements

Table 2 will show the functional requirements of the home monitoring system.

Table 2 functional requirements of home monitoring system

No	Modules	Functions
1	Raspberry pi 3	Raspberry Pi 3 is used in this project as a microprocessor which manages all the electronic appliance used. It will continuously read the data from all the attached sensors for monitoring any unusual data from sensors The Raspberry Pi is placed inside.
2	Raspberry pi camera	The Raspberry Pi Camera is used to recognize if somebody is passing by the front door.
3	DHT11	DHT11 sensor is used to measure the temperature and humidity in real time. And can stream it through flask.

Table 2: (cont)

4	Servo motor	A Servo Motor is used at door to shake it by moving the wing few degrees and get back to 0-degree multiple times using Pulse-Width Modulation (PWM).
5	Speaker	A speaker is used to play background sound with a recorded voice to let people think there is someone inside the house.
6	Flask	Flask provides native support for streaming responses through the use of generator functions.
7	Yagmail-mail	Yagmail is a module in python which used to send emails using Python. Yagmail Mail library is used to send a warning email if the camera detected suspicious person.

Table 2 shows the functional requirements of home monitoring system. All these functions in the system have a specific job must be doing it during using the system as the explanation in the table above for the functional requirement.

4. System Analysis

Before the system is implemented for the customers, the analysis and design phase are used to develop and build a home monitoring system that can be built. The information and data acquired would be analyzed in order to learn and understand the method to build. The project requirements, which describe the project's aims, scope, and significance, are an example of analytical outcomes that can be defined. Design is a system based on object-oriented design methodologies. The device is also more appealing as a result of the study and implementation results. The Analysis phase is critical for understanding the specifications in greater depth and ensuring that the system being developed fulfils the user's system needs. Results can be presented in the form of tables, figures, charts, diagrams, or other suitable formats. If required, raw data that is too lengthy to be put in this section can be moved to the appendix.

Flow charts have been created as part of the process of designing a home monitoring system to show how the system will be used in general. During this procedure, the device's architecture can be clarified in terms of how it performs in relation to the required modules. During the study and design phase, the machine designer saves the information and details on the system so that it can function properly. Furthermore, these stages drive and guide the system outlined in the flow chart, ensuring that users understand how to utilize the system from beginning to end. During the study and implementation of this system, any problems in the system to be constructed would be clear.

4.1 Software and Hardware Requirement

Table 4 shows the software and hardware requirements for the home monitoring system

Table 3: software and hardware requirements

Software	Hardware
Table 3: (cont)	

Python	Raspberry pi 3
Microsoft word	Servo motor
PowerPoint	Raspberry pi camera
Microsoft Excel	DHT11
	Speaker

4.2 Flowchart of the project

All of the system flowcharts will be thoroughly detailed in this section. With the use of flowcharts, the three phases of the system will be clearly illustrated.

4.2.1 Data Acquisition Phase

The first phase which leads in initializing the sensors and start reading the data and collect them for use purpose later.

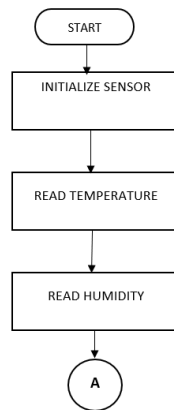

Figure 4: Data Acquisition (Phase 1)

Figure 4. depicts the data acquisition phase, during which the sensor is set up to detect and collect all of the required signals. Following the generation of sensor readings, all data will be forwarded to the Raspberry Pi 3 for use as an input in the next phase, which is security. Figure 5 depicts all of the processes involved in phase 2.

4.2.2 Security Phase

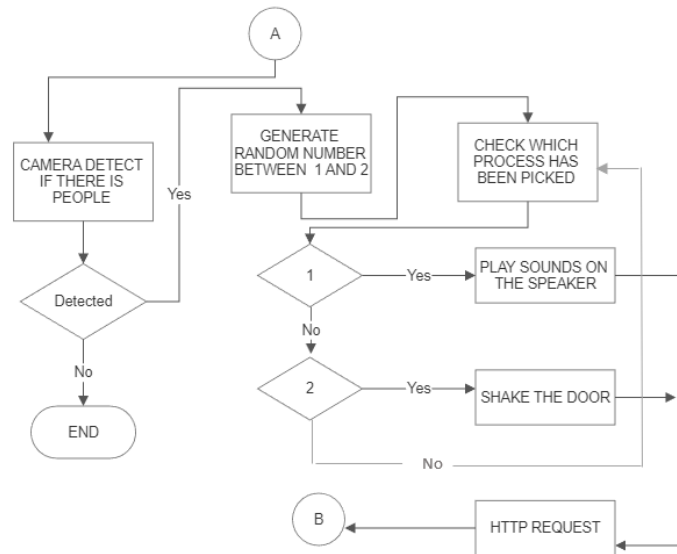

Figure 5: security (Phase 2)

Phase 2 is the largest and most essential phase of the project, according to Figure 4.2, where the camera will identify if someone walks by and be compared, as well as any unusual occurrences. After it identifies any aberrant readings, it will take action by playing a random scenario. A random number between 1 and 2 will be created, and the scenario will be chosen based on the value. To begin, turn on the speaker. Then, it will shake the door. If any of these scenarios occurs, it will submit an HTTP request, and it will take further action based on Phase 3, as illustrated in Figure 6.

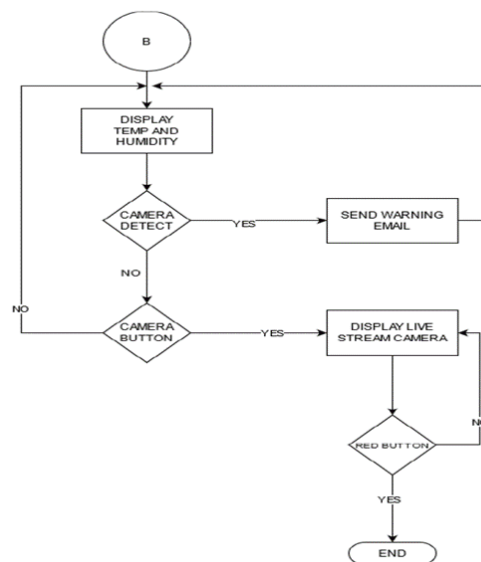

Figure 6: Dashboard (Phase 3)

Figure 6 depicts Phase 3, the final phase, in which it will display the temperature and humidity in the dashboard and then check the camera to see whether it detects anybody at all; if it does, it will send an email to the user; if it does not, it will check the camera button; if it is clicked, it will go to the live

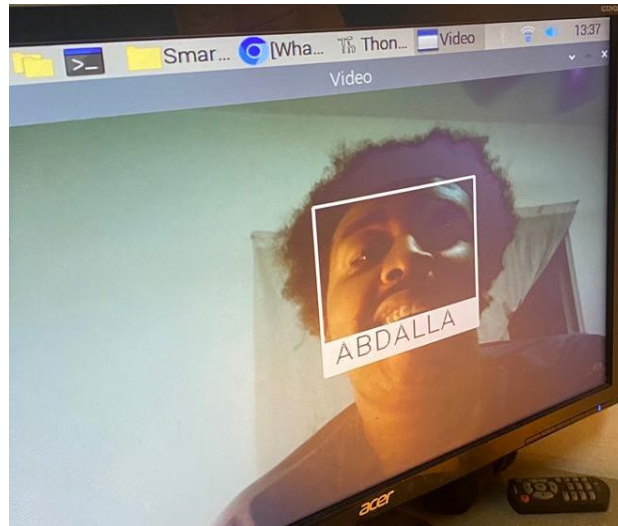

Figure 8: A face is detected using OpenCV and Face Recognition.

As shown in Figure 8, a face is detected by the camera. It shows a label around the face with the phrase “ABDALLA” is the person.

5.2 Security

A servo motor has been tested and been rotated for few degrees to move the door in the degree which I want. In my project case, the door should be Shaked. The servo motor is tested as shown in the figure 9 and 10.

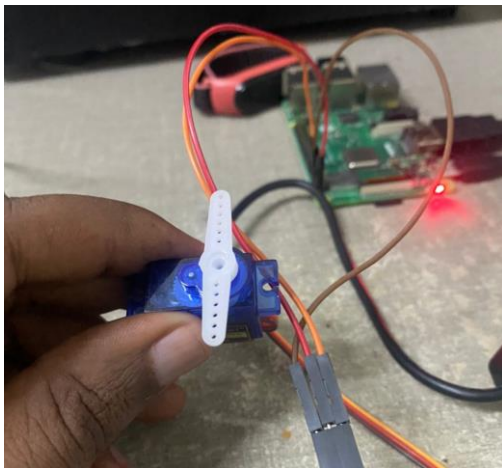

Figure 9: servo motor before the rotation

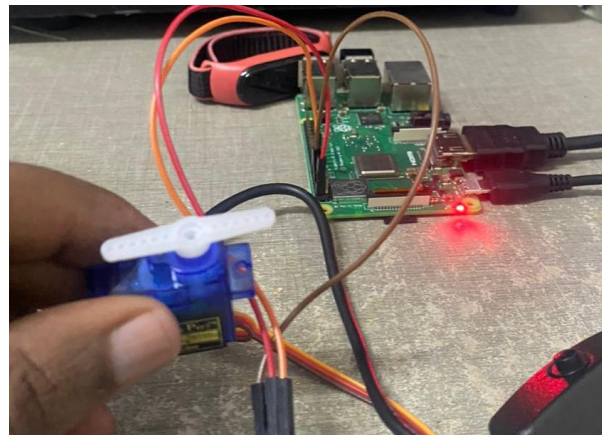

Figure 10: Servo motor after rotation

The servo motor is being rotated with few degrees (180 degree) for testing. In the actual project the degrees will reduced to show accurate shaking instead of half opening the door. Since it is to prevent the thieves from getting into house buy letting them that someone is inside the house.

5.3 Speaker

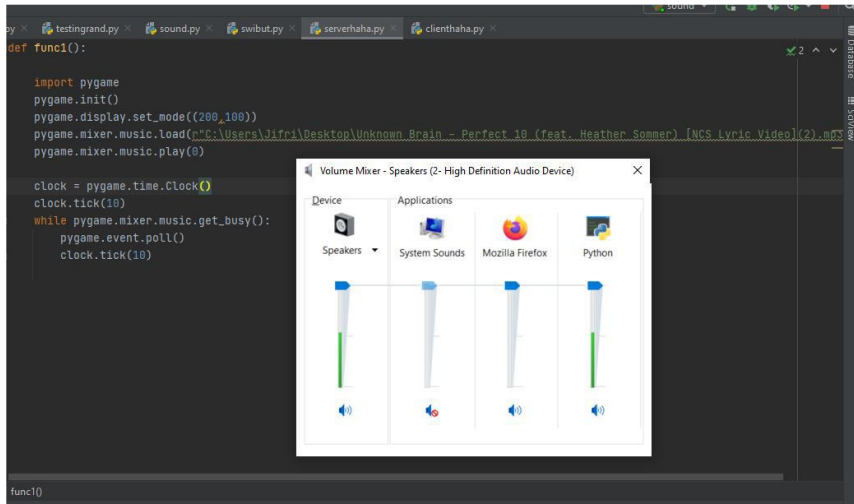

Figure 11: Python code to play a specific sound by loading it from its path

As shown in Figure 11, a python code was used to play a specific sound by loading it from the path given in the code. The pygame library was called which is compatible with RPi 3 to be able to play the sound. The sound was played successfully as you can see through the Volume Mixer.

5.4 Dashboard/Flask

This is Phase 3 which shows the UI of website and how user can handle the project with and easy to use website.

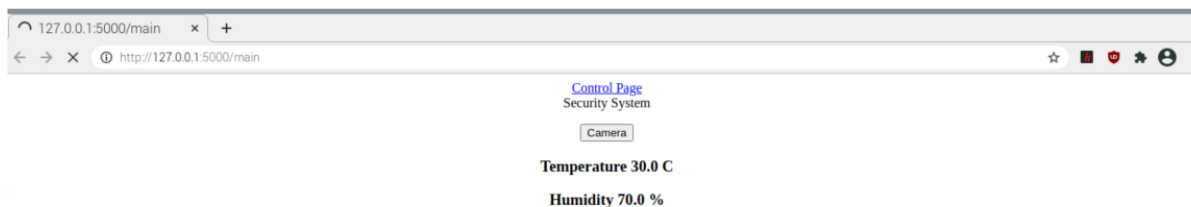

Figure 12: Shows the temperature and humidity inside the house with camera live stream.

As shown in Figure 12, a website shows both Temperature and Humidity with real time data along with Camera button to produce the live stream. Flask library was obtained to run a local host with the HTML file has been made which makes it easier to do IoT.

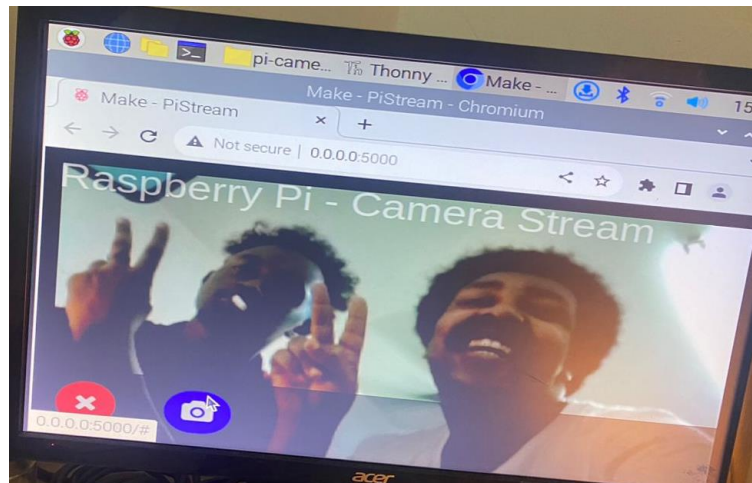

Figure 13: camera stream from route in the local host.

As shown in Figure 13, live stream by the camera is produced in the local host through flask stream library. The route opens HTML file called index.html which it includes CSS properties for Stylish purpose. The red button is to stop or start the live stream.

Thus, there blue camera button you can take a picture as well to anything during the stream too. Therefore, in figure 14 it shows the life stream thrown phone web server.

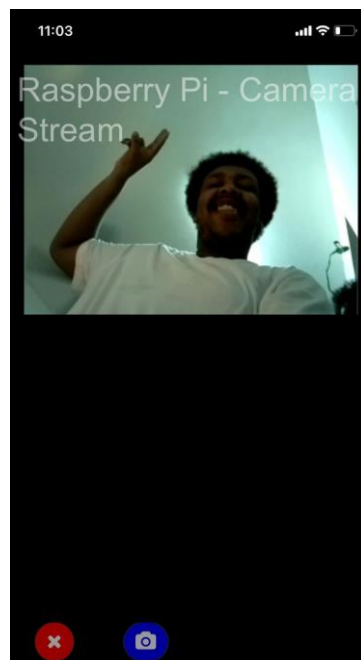

Figure 14: watch the stream the phone

5.5 Yagmail

As shown in Figure 5.12, an Email has been received shows an alert message with an attachment of a taken picture by the person which has been detected by the camera.

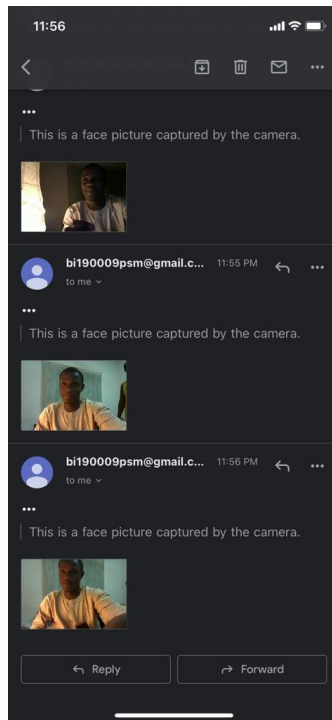

Figure 15: several emails been sent to alert the user that someone is been detected by the camera.

6. Conclusion

This Home Monitoring System developed in this project has successfully integrating the concept of Internet of Things (IOT) where the system is embedded with sensors, camera, bulb, speaker, microprocessors and Wi-Fi communication for data transmission.

In this project, all the system phases were integrated together and were able to communicate with each other in order to successfully assembled the final project were monitoring the house and focusing in its security are achieved based on detecting their faces and send alerts to the user in real time manner. Also, a web application has been successfully built for monitoring. The integration between the hardware and the web application is working without any issues integrating the two system together with the help of HTTP protocol. However, the project also had some limitations and issues that will be mentioned in the next section with possible solutions for future improvement.

Acknowledgment

The authors would like to thank the Faculty of Computer Science and Information Technology, University Tun Hussein Onn Malaysia for its support.

References

- [1] A. S. Romadhon, "System Security and Monitoring on Smart Home Using Android," *J. Phys. Conf. Ser.*, vol. 953, no. 1, 2018, doi: 10.1088/1742-6596/953/1/012128.
- [2] S. Kumar, P. Tiwari, and M. Zymbler, "Internet of Things is a revolutionary approach for future technology enhancement: a review," *J. Big Data*, vol. 6, no. 1, 2019, doi: 10.1186/s40537-019-0268-2.
- [3] , Bassam Ruwaida and T. Minkkinen, "Home Automation System : A cheap and open-source alternative to control household appliances," 2013, [Online]. Available: [http://www.diva-portal.org/smash/record.jsf?dswid=1880&aq=\[\[\]\]&aq2=\[\[\]\]&sf=all&aqe=\[\]&af=\[\]&searchType=SIMPLE&sortOrder=author_sort_asc&onlyFullText=false&noOfRows=50&language=en&pid=diva2:679674&jfwid=1880](http://www.diva-portal.org/smash/record.jsf?dswid=1880&aq=[[]]&aq2=[[]]&sf=all&aqe=[]&af=[]&searchType=SIMPLE&sortOrder=author_sort_asc&onlyFullText=false&noOfRows=50&language=en&pid=diva2:679674&jfwid=1880).
- [4] A. Doehrman and D. Cochran, "Senior Design IOT : Smart House."
- [5] R. Halder, S. Sengupta, S. Ghosh, and D. Kundu, "Artificially Intelligent Home Automation System Based on Arduino as the Master Controller Rituparna Halder , Susmit Sengupta , Sudipta Ghosh , Debasish Kundu," pp. 41–45, 2016.
- [6] J. H. Nord, A. Koohang, and J. Paliszkiwicz, "The Internet of Things: Review and theoretical framework," *Expert Syst. Appl.*, vol. 133, pp. 97–108, 2019, doi: 10.1016/j.eswa.2019.05.014.
- [7] I. I. Pătru, M. Carabaş, M. Bărbulescu, and L. Gheorghe, "Smart home IoT system," *Netw. Educ. Res. RoEduNet Int. Conf. 15th Ed. RoEduNet 2016 - Proc.*, 2016, doi: 10.1109/RoEduNet.2016.7753232.