

## **Design an Off- Grid Solar System to Identify the Accuracy of the Data Obtained by Calculation and Actual Situation**

**Sharvin<sup>1\*</sup>, Mohd Fadly Abd Razak<sup>1\*</sup>,**

<sup>1</sup>Department of Electrical Engineering Technology, Faculty of Engineering Technology,  
Universiti Tun Hussein Onn Malaysia, Muar, 84600, Pagoh, Johor, MALAYSIA

\*Corresponding Author Designation

DOI: <https://doi.org/10.30880/peat.2023.04.02.032>  
Received 2 July 2023; Accepted 12 July 2023; Available online 12 July 2023

**Abstract:** This Off-grid solar power systems are becoming more and more common as independent and sustainable sources of electricity, especially in outlying locations without connection to the traditional power grid. Several factors, including solar panel capacity, battery storage capacity, charge controller efficiency, and inverter performance, will be taken into account to evaluate the correctness of the generated data. The steps in the design process involve determining out the target systems energy needs, estimating the solar panel capacity needed to produce the desired amount of electricity, choosing a suitable battery storage system to hold any extra energy, and selecting an effective charge controller and inverter. To assess the designs accuracy, the computed values will be contrasted with the actual system performance. The evaluation procedure will take into consideration actual environmental factors such as weather patterns, solar radiation levels, temperature changes, and system losses. To measure the actual energy generation, battery state of charge, and overall system performance over a predetermined timeframe, monitoring equipment will be installed. To evaluate the accuracy of the design, this data will be compared with the projected values discovered by calculations. The results of this study will give important information on the precision of the data collected through calculations for off-grid solar system design. Future designs will benefit from its optimization and refinement, resulting in off-grid solar systems that are more dependable and effective.

**Keywords:** Off Grid Solar Power System, Calculations, Environmental Factor

### **1. Introduction**

Solar panels (photovoltaics) were a luxury item used to generate electricity for specific uses up until twenty years ago. Solar panels are now used more and more in the process of producing power as new technologies have made it possible to create them at considerably reduced costs over time. These systems do not have any electrical connections to the grid and autonomously deliver the electricity they create to the user, in contrast to solar power plants connected to the grid. Energy storage devices are

required since the major source, the sun, fluctuates and is not permanent during the day and night. These systems distribute extra electricity generated and store it in batteries for later use by the consumer. Off grid solar system is a kind of backup solar power system that operates both during the day and at night. During the day, the solar panel charges the battery. Inverter uses battery power during the night to power your appliances, machinery, electronics, agricultural equipment, and industrial equipment. Following that off grid system uses up the power of sun to meet up with the energy demands without depending on power grid. Before the expansion in technology off grid solar system needed big space and the expenditure to build this system was expensive. However, improvements in solar technology over the past ten years have reduced the cost and increased the efficiency of solar equipment, helping to mainstream them. RVs and rural cabins powered exclusively by off-grid solar systems are increasingly a reasonably typical sight [1]. The off-grid system provides required electricity to homes, villas, and other types of 2 outside of cities where people reside and need electricity but there is no electrical supply, an off-grid solar system is a great option. In addition, every system is built around a calculation to estimate and create a concept of simulation to analyze the accuracy of system with the actual value. This also applies to this project. This research revolves around calculation used to build a small off grid system. Following that calculation goes into several steps such to choose proper equipment, check output gained and other minor calculations. Calculation plays a pivotal role in getting accurate reading and getting the expected result without errors [2]. Furthermore, this calculation process is a theory of estimation to compare and understand the differences or similarities of the built device. The research uses calculation to prove or check on error of this off grid system during the real time usage.

### 1.1 Problem Statement

Off-grid solar systems are becoming more and more popular, but there are still a number of issues that need to be resolved in order for them to be widely used and effective. These difficulties restrict off-grid solar system's ability to deliver optimal performance and sustainable energy access to communities. The precision and dependability of the calculations used to construct these systems is one of the main issues. For solar panels, batteries, and inverters to be the proper size and provide customers with the energy they require, precise calculations are essential. Calculations that are overly precise can result in systems that are either too huge, which results in inefficient energy output, or too tiny, which results in insufficient power. 5 The performance variability found under everyday conditions is another problem. Off-grid solar system's capacity to reliably satisfy energy needs can be impacted by variables such as changing climates, changing sunshine availability, and shifting energy consumption patterns. To provide a dependable and consistent energy supply from these systems, it is essential to comprehend and address this variability. Particularly in economically underdeveloped areas, the initial expenditures related to off-grid solar system installation and maintenance provide a substantial hurdle. Making off-grid solar systems more cost-effective and accessible requires investigating financing possibilities, finding cost-effective solutions, and lowering startup and ongoing costs

### 1.2 Objectives

There are two main objectives for this research which are:

- i. Create a simple off-grid solar system utilizing tools and calculation methods to ensure accurate component size for solar panels, batteries, and inverters for the best system performance and energy production.
- ii. Identify the information gained from the output voltage and current produced by the solar system for comparison with the information obtained from calculations.

### 1.3 Scope of the study

- i. Using dependable instruments and mathematical techniques enables optimal system performance and effective energy generation.
- ii. To make sure the project assesses the alignment between expected performance and actual system operation, allowing to improve the correctness of the overall design and develop the calculation techniques

## 2. Materials and Methods

### 2.1 Materials

In this project, the materials must include is lead acid battery which is needed to be charge and power the load [3]. The following will be proper or well rated solar panel which must be justified through calculation before buying [4]. Furthermore, type of load a bulb which can withstand the power or charge that will be given by the battery. The load will be 10watt bulb which is good enough for this small scale off grid system. The solar charge controller can be 10A, 20A, and 30A which is good enough for this off grid system. The solar charge will control the off-grid system. The amount of charge and amount discharge all this are under charge controller. Finally, inverter is needed to convert the direct current (DC) to alternating current (AC). Since the load is small any inverter will be suitable for the test.

### 2.2 System Block Diagram

Figure 1 The solar is going to charge the battery so the current and voltage will be taken from the battery while its being charged and discharged. The voltage sensor and current sensor will be connected to the battery to detect voltage and current. ESP32 is used to read the data and publish it to the Blynk app where the data will be recorded using the Wi-Fi or hotspot. Followed by that inverter is also connected to ESP 32 and the both sensor this is to read the discharge current and voltage of battery while powering the load.

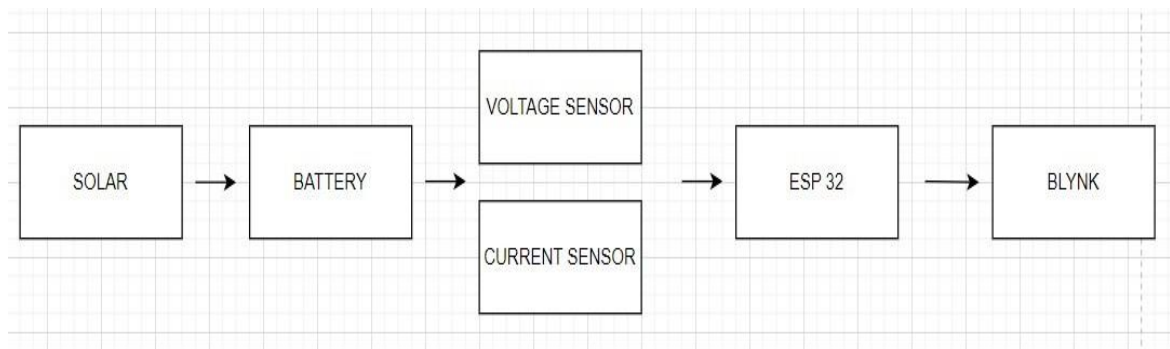

**Figure 1: Block Diagram of the project**

### 2.3 System Flowchart

For Figure 2, The system for this research begins with the findings in literature review. The literature review consists of several calculations. The several calculations will be tested to analyze whether the calculation is relevant to the data received from the simulation. If the data is relevant to the theory calculation which was gained from literature review it will be a success. Unfortunately, if the result is in a negative way which also means the data gained from simulation isn't relevant to calculation. In that case the simulation will be done again or will be compared to different choice of calculation.

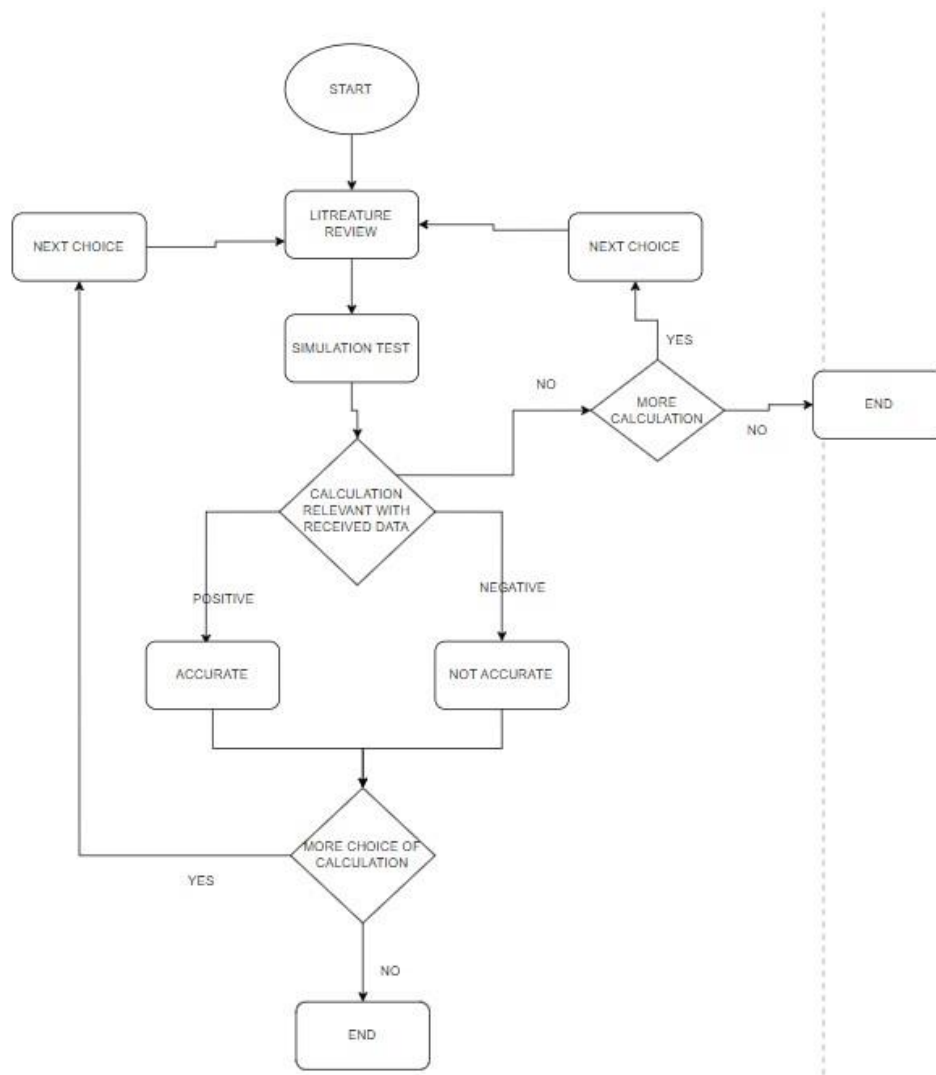

**Figure 2: Flowchart of the project**

### 2.3 Limitation of project

The project has certain limitations that should be considered. Firstly, the monitoring system developed is primarily focused on small-scale grid systems and may not be easily scalable or suitable for larger or more complex grid setups. Compatibility with different types of solar panels, sensors, or peripheral devices may also pose challenges [5]. Followed by that the calculation gained from resources cannot be trusted or expect highly enough to get the perfect result. The calculation is just an estimation or guide build and test this project. The differences can be due to nature too. The result cannot be predicted beforehand.

### 2.4 Method of real time testing

The project is tested using a Blynk app. The app will receive data from ESP32 which is connected via wi-fi. The system will update the voltage value of battery during charging and discharging process. The load will consume the energy from the battery. In this case to power the load the battery will be charged using solar panel to the lead acid battery. It will be charged in open area from morning to around 5 in the evening. This is for the charging process. After this the battery will be switched on to power the load until light switches off due to depletion of battery. The app will show the declination of battery charge while the battery is running. As for the duration of hours taken for battery to discharge

fully will be observed physically. Time will be set from start point and end once the system is unable to power the load. Followed by that multimeter is used to take reading of battery every 3 hours. This process is done to assess the comparison between Blynk app and manual reading. All this process will be done for 4 different variations of solar panel and battery rating. This will be done according to calculation and then swap is done to see the differences in reading. All this must be done to receive the result and compare it with calculation

### 3. Results and Discussion

The real time testing of the off-grid system results will be shown in this chapter. The calculations to produce the combination of solar panel and battery will also be explained here. Following the running hours results also will be stated along with above results.

#### 3.1 Results

Table 1 illustrates the calculation that was used to design 2 types of off grid-system to do the real time tests. These calculations determine the rating of solar panel and battery size to be used.

Formula 1	Formula 2
Energy consumption= Watts x Hour $10W \times 6H = 60H$	Energy consumption = Watts x Hour $10W \times 8H = 80H$
Solar panel Rating= Watthour ÷ time period $60Wh \div 4h = 20W$	Solar panel Rating = (Watt hour ÷ Peak sun hour) x basic system $(80Wh \div 5h) \times 1.4 = 22.4W$
Battery sizing (Ah)= Watthour ÷ Voltage $60wh \div 12 = 5Ah$	Battery sizing = (watthour x per day ÷ voltage) / DOD x efficiency $(80Wh \times 1 \div 12) \div (0.5 \times 12) = 16Ah$
Lead acid battery 50% = Watthour ÷ (Voltage x 50%) $60 \div (12 \times 0.5) = 10Ah$	

**Table 1: Formula 1 and 2 to design off-grid system**

Table 1 presents the utilization of formulas for designing off-grid systems. The first formula determines the energy consumption for a period of 60 hours, resulting in a 20W solar panel. The calculation involves dividing the time period of usage to estimate the panel's capacity. Additionally, the battery size or ampere hour is determined by dividing the watt-hour by the voltage. It's worth noting that lead acid batteries utilize only 50% of their capacity, so the watt-hour is divided by the product of voltage and 50%. Moving on to the second formula, the energy consumption remains the same at 80 hours. This leads to a solar panel rating of 22.4W, obtained by dividing the watt-hour by the peak sun hour and then multiplying it by the basic system rating. The basic system rating encapsulates efficiency and related factors into a single value. For determining the battery size, the watt-hour is multiplied by the number of days and divided by the voltage (12V) and depth of discharge (50%), further multiplied by the battery's efficiency. In the case of the first formula, a 20W solar panel and a 12Ah battery are chosen. Opting for a 12Ah battery provides a safety margin to prevent inadequate power supply, as larger capacity is preferred. In the case of the second formula, due to the unavailability of a 22.4W solar panel in the market, a 30W panel is selected. Similarly, a 16Ah battery is chosen based on availability.

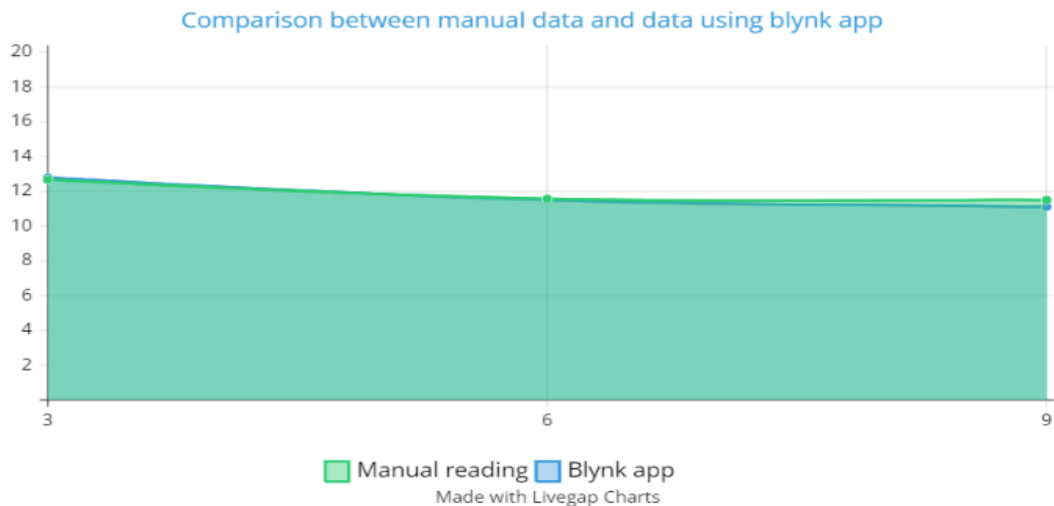

**Figure 3: Voltage graph of 20W and 12Ah (Formula 1)**

Figure 3 displays the voltage data from start to ending period. The voltage charge was higher than expected in calculation which was an estimation of 12V. After a certain period of time voltage drops when the battery was nearing its capacity to produce power for the load. Highest recorded voltage was 12.78V.

Type of reading (V)	3pm	6pm	9pm
Blynk app	12.78V	11.5V	11.11V
Manual reading	12.67	11.57	11.5

**Table 2: Reading of voltage compared between Blynk app and Manual reading 1**



**Figure 4: Comparison graph of manual data and Blynk app**

Figure 4 displays the data of voltage is compared between 2 types of reading. The data is gained from manual reading using multimeter and the other one using Blynk app. Following that reading is taken every 3 hours starting from 3 pm to 9 pm to check on the decline of voltage. Both have a very similar reading. The highest voltage is 12.78V and lowest is 11.5V.

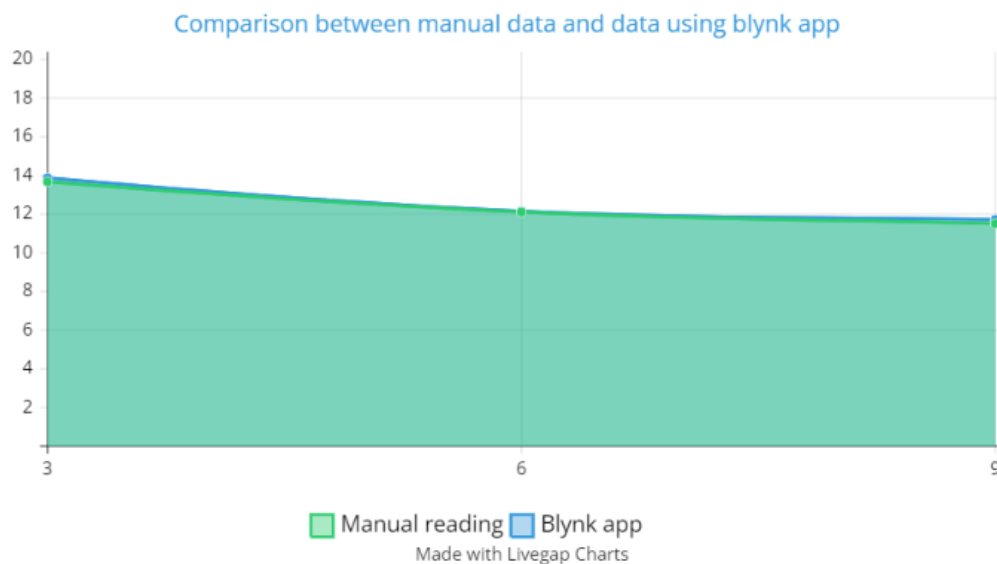

**Figure 5: Voltage graph of 30W and 17Ah (Formula 2)**

Figure 5 displays the voltage data from start to ending period. The voltage charge was higher than expected in calculation which was an estimation of 12V. After a certain period of time voltage drops when the battery was nearing its capacity to produce power for the load. Highest recorded voltage was 13.87V. This result is based on the 2<sup>nd</sup> formula the voltage is higher due to the solar panel rating and battery capacity.

Type of reading (V)	3pm	6pm	9pm
Blynk app	13.87V	12.15V	11.11V
Manual reading	13.67V	12.11V	11.51V

**Table 3: Reading of voltage compared between Blynk app and Manual reading 2**



**Figure 6: Comparison graph of manual data and Blynk app**

The data of voltage is compared between 2 types of reading. The data is gained from manual reading using multimeter and the other one using Blynk app. Following that reading is taken every 3 hours starting from 3 pm to 9 pm to check on the decline of voltage. Both have a very similar reading. The highest voltage is 13.87 V and lowest is 11.11V.

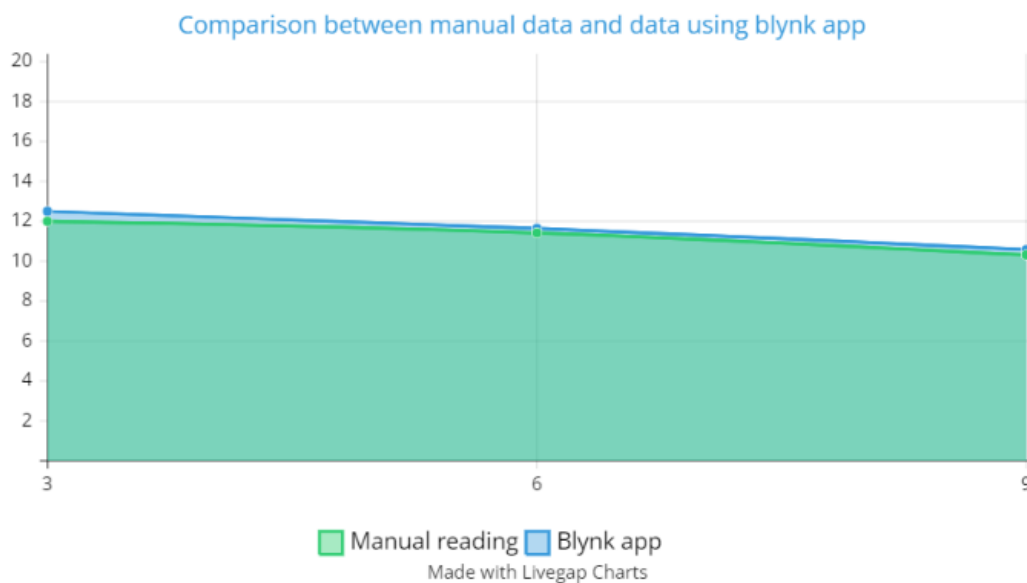

**Figure 7: Voltage graph of 20W and 17Ah (SWAP 1)**

In this change over test the solar panel could not charge the 17Ah battery as efficient as the 30W solar panel. The voltage in this was only 12.15V and to be considered the change in weather which was big factor of difference in charging. The swap testing didn't produce enough charge to the battery. This didn't reach expectation due to the weather and size of solar panel.

Type of reading (V)	3pm	6pm	9pm
Blynk app	12.5V	11.65V	10.58V
Manual reading	12V	11.42V	10.32V

**Table 4: Reading of voltage compared between Blynk app and Manual reading 3**



**Figure 8: Comparison graph of manual data and Blynk app**

The data of voltage is compared between 2 types of reading. The data is gained from manual reading using multimeter and the other one using Blynk app. Following that reading is taken every 3 hours starting from 3 pm to 9 pm to check on the decline of voltage. Both have a very similar reading. The highest voltage is 12.5V and lowest is 10.32V.



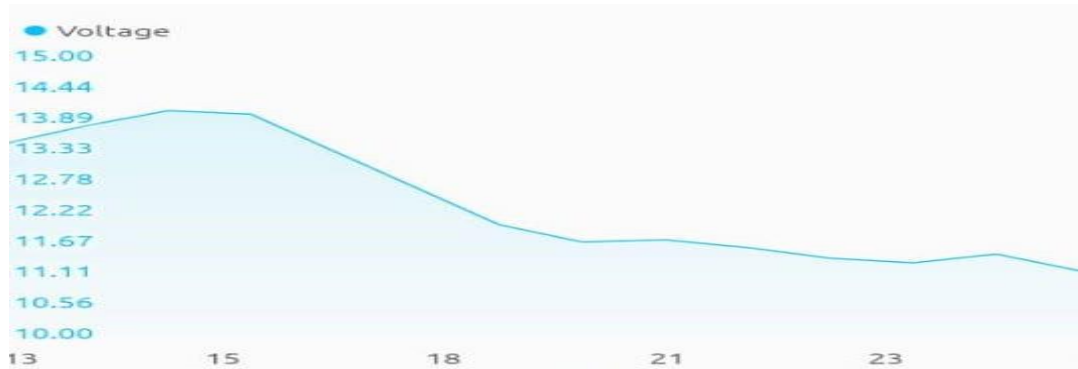
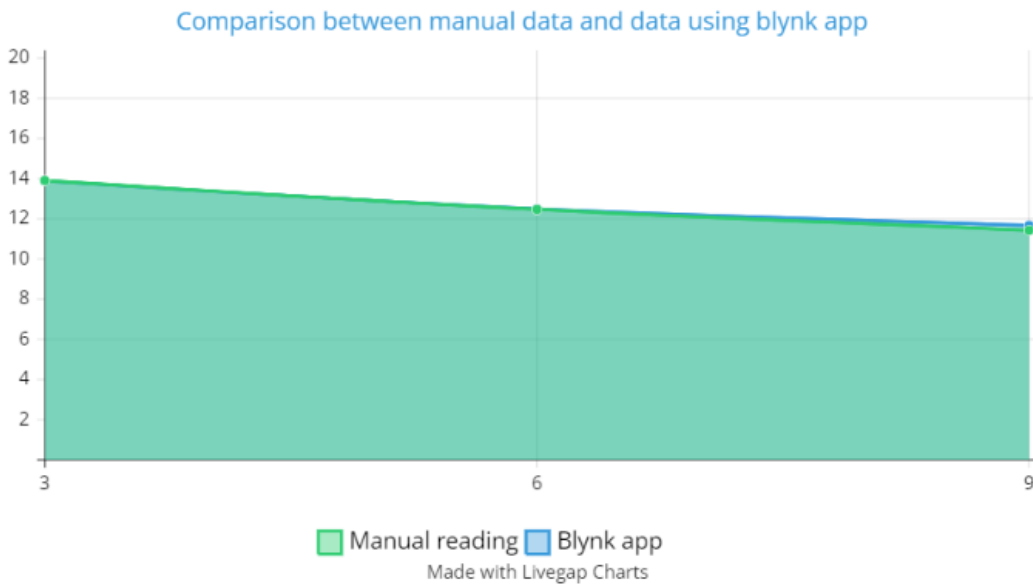

**Figure 9: Voltage graph of 30W and 12Ah (SWAP 2)**

This time the 12Ah battery was charged using 30-watt solar panel. This time charge given to this battery was higher and the peak voltage is nearly 12.22 volts. This could be due to the strong sunshine and for a long period which result in good charge

Type of reading (V)	3pm	6pm	9pm
Blynk app	13.89V	12.50V	11.67V
Manual reading	13.91V	12.47V	11.43V

**Table 5: Reading of voltage compared between Blynk app and Manual reading 4**



**Figure 9: Comparison graph of manual data and Blynk app**

The data of voltage is compared between 2 types of reading. The data is gained from manual reading using multimeter and the other one using Blynk app. Following that reading is taken every 3 hours starting from 3 pm to 9 pm to check on the decline of voltage. Both have a very similar reading. The highest voltage is 13.89V and lowest is 11.43V.

### 3.2 Running Hours Calculation

$$\text{Battery capacity after DOD} \div \text{Energy Consumption} = \text{Running Hours}$$

$$6AH \div 0.6H = 10H$$

$$\text{Battery capacity after DOD} \div \text{Energy Consumption} = \text{Running Hours}$$

$$8.5\text{AH} \div 0.8\text{H} = 17\text{H}$$

This calculation is used to determine how long can the battery sustain and power the load. This is just a theoretical calculation of estimation. For the battery capacity is cut half for 12AH and 17AH. This is due to the lead acid battery depth of discharge which is 50%. The calculated running hours is 10H and 17H respectively.

HOURS	20W 12AH	30W 17 AH	20W 17AH	30W 12 AH
Expected running hours	10 H	17 H	17 H	10 H
Actual running hours	6.5 H	15 H	7 H	9 H

**Table 6: Comparison of expected and actual running hours**

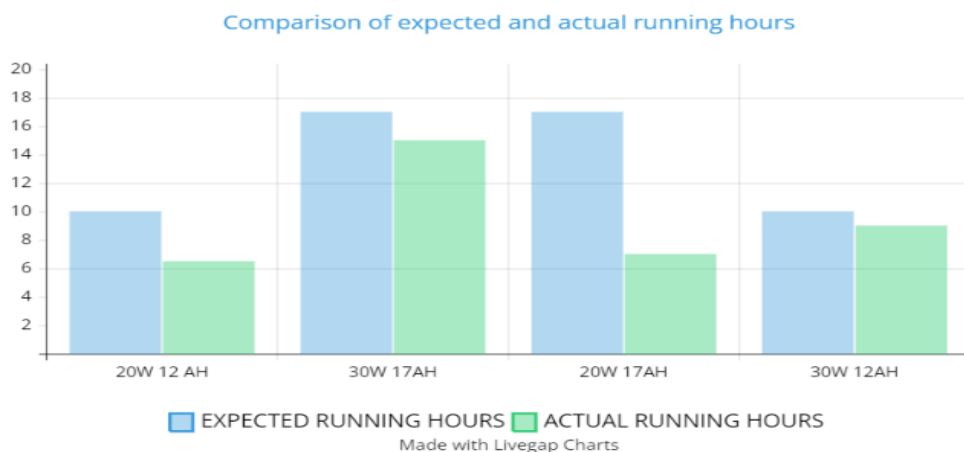

**Figure 10: Running hours comparison graph**

Running hours is recorded through physical observation. The observation was done until the light of 10W bulb goes off. The battery of 12 AH is expected to run for 10 hours and 17 AH for an expectation of 17 hours. Four stages of real time test were taken. First was 20W 12 AH where the expected runtime is 10H and actual runtime is 6.5H. The light goes off earlier than expected might be due to the less amount of sunshine on that particular day. The following set of test is the result of 2<sup>nd</sup> formula. The expected hours to withstand should be 17 hours. However, running period came to an end after 15 hours. Furthermore, 20W 17AH was tested to see how it pairs up. 17 AH battery is expected to power for 17 hours but the power was cutoff after just 7H. The power charged is less due to the smaller solar panel and less sunshine period too. The final test used 30W and 12 AH battery where the power was cutoff after 9 hours. The expectation was 10 hours. All the expected result is not the same during actual test. The test can be affected by many factors such as autonomy days, solar panel rating, less accuracy of calculation and the less sunshine period. In calculation many things need to be considered to get a perfect answer. Although all this can be added in calculation to get an expected result. The nature is unpredictable at times can't get the accurate reading.

### 3.2 Discussion of real time test and calculation

This test was conducted in 4 different combinations. All of the combination didn't tally with the calculation of charge current and discharge current. Meanwhile the voltage is almost the same because it is the amount that needed to produce by the battery. The charging voltage sometimes is less than 12V due to the autonomy days that occurs in this real time test period. The same problem resulted in lower charging current compared to calculation. Meanwhile, the voltage and current charge also differs according to different combination of solar panel and battery. Larger solar panel watt can charge faster or more than a smaller one. Following that the battery can be a factor too. The battery capacity must hold the charge contributed by solar panel. Bigger battery capacity can hold and discharge more compared to a smaller one. As for all the factors that can affect the current and voltage of an off grid solar system cannot be calculated accurately using findings from internet and other research papers. Every possibility factor must be considered to get the utmost accurate calculation. Unfortunately, the nature doesn't work accordingly which affects the charging process of off grid solar system a lot.

### Conclusion

In conclusion, this research is basic concept of trial and error. This is due to the fact that this calculations from sources are tested to check whether the output produced is the same as the calculation theory from that respective source. Furthermore, this concept of research will benefit to find the best calculation to build a more efficient off grid solar power system. On top of this the higher accuracy the better the output could be produced from this off-grid system. It is possible to assess the accuracy of the data gained through calculation and contrast it with the actual situation by constructing an off-grid solar system with precise and dependable components, putting in place a thorough monitoring and data recording system, and performing routine calibration and maintenance. This makes it possible to compare the energy production, storage, and consumption results with the predicted results. The performance and dependability of the system can be improved by identifying and analyzing any differences between both calculated and actual data.

### Acknowledgement

Authors would like to thank the Universiti Tun Hussein Onn Malaysia especially Faculty of Engineering Technology (Department of Electrical Engineering Technology) for supporting and providing information sources that assisted the research from beginning until everything is completed successfully.

### References

- [1] S. Y. Wong and A. Chai, "An Off-Grid Solar System for Rural Village in Malaysia," *2012 Asia-Pacific Power and Energy Engineering Conference*, Shanghai, China, 2012, pp. 1-4, doi: 10.1109/APPEEC.2012.6307162
- [2] Pelamis wave power. (n.d.). Solar Panel Size Guide: How Much Do You Need For Your Home? Retrieved from pelamiswave.com: <https://www.pelamiswave.com/solarpanel-size-guide/>
- [3] Muzaffar, C. B., & Iqbal, M. T. (2020, November). Design and analysis of off grid solar system for DC load of a house in Pakistan. In 2020 11th IEEE Annual Information Technology, Electronics and Mobile Communication Conference (IEMCON) (pp. 0804-0807). IEEE.
- [4] Al-Shamani, A. N., Othman, M. Y. H., Mat, S., Ruslan, M. H., Abed, A. M., & Sopian, K. (2015). Design & sizing of stand-alone solar power systems a house Iraq. *Design & Sizing of Stand-alone Solar Power Systems A house Iraq* Ali, 145-150...

- [5] Karuppusamy, P. (2020). A sensor based IoT monitoring system for electrical devices using Blynk framework. *Journal of Electronics and Informatics*, 2(3), 182-187.