

Converting Food Waste Generation from Household Using Bokashi Method for Composting

Hasslina Awang¹, Zarizi Awang^{1*}

¹Department of Civil Engineering Technology, Faculty of Engineering Technology, Universiti Tun Hussein Onn Malaysia, 84600 Pagoh, Johor, MALAYSIA

*Corresponding Author Designation

DOI: <https://doi.org/10.30880/peat.2021.02.02.009>

Received 13 January 2021; Accepted 01 March 2021; Available online 01 December 2021

Abstract: In Malaysia, around 8000 tonnes of food and kitchen waste is produced every day and sent to landfill that produces methane gas, bad odor and greenhouse effect. The waste also gives impacts on social and economic. Thus, the objectives of this study are to design a suitable Bokashi bin in achieving an affordable and practical usage for the household. Second, to convert the food waste generated from the household into an organic soil fertilizer via the best formulated Bokashi method using effective microorganism (EM). In addition, this study analyses the effect of Bokashi application on plant growth as an organic soil fertilizer. A Bokashi bin was designed with low cost and less maintenance to handle. Three different amounts of EM were used for the formulation of EM Bokashi for 7 days and fermented in an airtight container for 14 days. Next, the fermented food waste was buried for 30 days and Bokashi was applied on plant growth (*Carica papaya* L.) as organic fertilizer for 35 days. Parameters of height of plant, number of leaves, number of the branch and length of leaves were analysed using different ratios of treatments. The result showed that T4 (1 kg of soil and 600 gm of Bokashi compost) gave higher performance mean with 16.96 cm (height of plant), 6.40 (number of the branch), 3.60 cm (length of leaves) and 6.40 (number of leaves) compared to those of T1, T2 and T3. This study helps to minimize the environmental pollution, eliminate bad odor caused by food waste and creates a sustainable method in achieving zero waste in the future.

Keywords: Bokashi Method, Effective Microorganism, Treatment, Sustainable Method

1. Introduction

In Malaysia, around 0.5 – 0.8 kg uneaten food per day was discarded and this amount will increase in a few years as the population of Malaysia is expected to reach 33.4 million by 2020 and 37.4 million by 2030. Food materials produced from human consumption that left uneaten, lost or discarded through the food supply chain from farm and organic waste that has been discharged from the cafeteria, commercial kitchen, household or food processing plants [1]. Food waste will give an impact on the

current environmental issues that will contribute to the production of greenhouse gases in the landfill. Greenhouse gases that lead to climate change can be emitted [2].

Bokashi is a fermented organic matter from the Japanese term. It is used as starter fermentation or a microbe that can be beneficial since it can supply organic matter to the soil. Bokashi is composted through the fermentation process using EM to assist the composting process. The papaya tree (*Carica papaya* L) is being chosen due to semi-woody, fast-growing and others. Papayas are grown from their seeds as its development is fast [3].

The presence of food waste in large quantity has attracted a lot of attention and worrisome as social, economic and environmental issues. Food waste from household and others will be sent to landfill for disposal. Rotten food can produce a large amount of methane gas and be harmful to human since these gases will lead to the greenhouse effect and global warming. Besides, can create a bad smell since it contains decaying and putrescible materials such as meat or vegetables. This condition will not only give unpleasant condition but can harm people's health and environment due to toxic leachate that may contain hazardous materials, groundwater contamination that harms the sources of drinking water and limited land to dump.

Thus, the objectives in this study are to design a suitable Bokashi bin in achieving an affordable and practical usage for the household. Second, to convert the food waste into organic soil fertilizer via the best formulated Bokashi method using the effective microorganism (EM). The last objective is to analyse the effect of Bokashi application on plant growth as an organic soil fertilizer

2. Materials and Methods

2.1 Materials

The materials needed and used in this project are molasses, effective microorganism (EM), corn bran, pipe head, dechlorinated water, round container (20 cm height and 24 cm of diameter), pot (11 cm height and 14 cm diameter) and food waste such as eggshells, fruit and vegetables.

2.2 Carbon and Nitrogen source

Green and browns serve as the basic source of composting materials which are Carbon (C) and nitrogen (N). The greens are the wastes of the kitchen, while the brown are dried leaves and soils. Greens are discarded vegetables, fruit peels, coffee or tea grounds that high in nitrogen, the browns are dry leaves and soils with high carbonate. Different materials are going to have a different C/N ratio. The optimum ratio for this composting is 25.0 – 30.0 % [4].

2.3 Methodology of flow chart

Figure 1 shows the methodology of the flow chart that has been used as a guideline in order to achieve the objectives. First, do the objective analysis of the study and literature review. Next, design the bins that are suitable for household usage with practical, easy to handle and affordable. After designing the bins, do the formulation of Bokashi for 7 days to find the best formulated EM Bokashi and fermentation of food waste for 14 days in an airtight container. After the fermentation process for 14 days, the food wastes were buried into the soil for 30 days and application of Bokashi and data collecting for 35 days. Next, do the data analysis and discussion. Lastly, do the conclusion and recommendation.

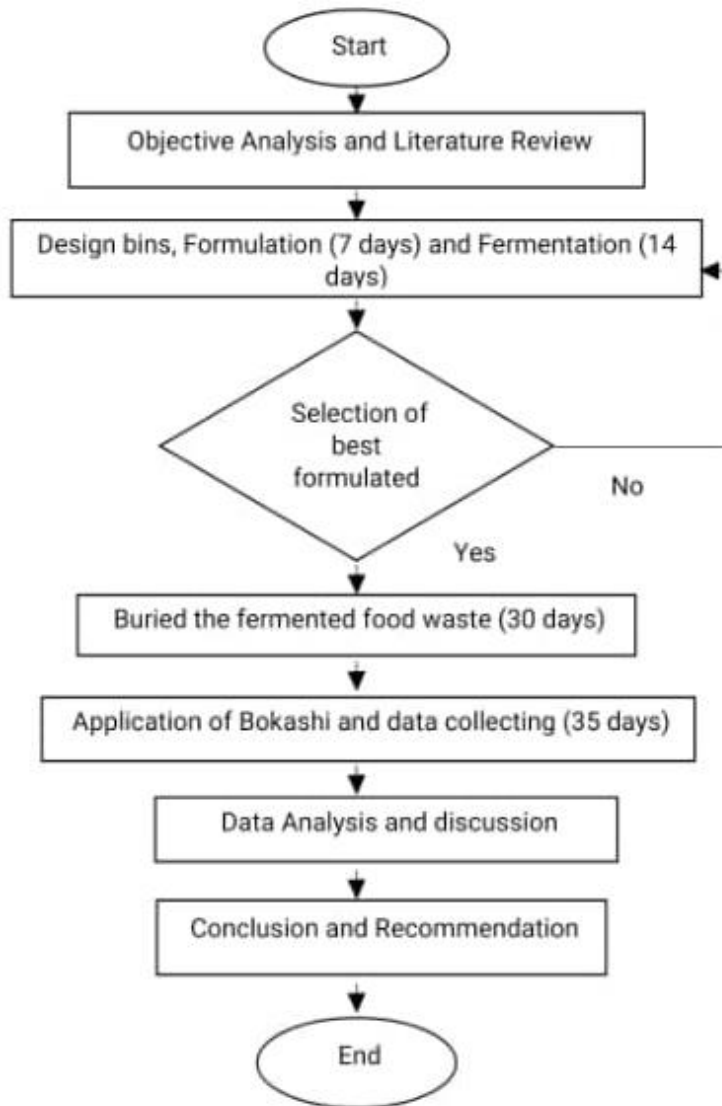

Figure 1: Methodology of flow chart

2.4 Procedure to convert food waste into soil organic fertilizer

Table 1: Converting food waste into soil organic fertilizer

| Procedure | Contents | Days |
|-----------|--------------------------------|------|
| 1 | Formulation of EM Bokashi | 7 |
| 2 | Fermentation of food waste | 14 |
| 3 | Buried the fermented materials | 30 |
| 4 | Application of Bokashi on soil | 35 |

Table 1 shows the procedure to convert food waste into soil organic fertilizer. First, EM Bokashi is fermented made from dechlorinated water, corn bran, molasses and EM for 7 days. After 7 days, it will be used for fermentation of food waste for 14 days in an airtight container. After fermented of food waste, the materials will be buried into the soil for 30 days as it is acidic and begins its second step of decomposing in the soil with aid of soil microbes. Next, after 30 days. The soil can be used for the application of Bokashi as the end result is organic soil fertilizer.

3. Results and Discussion

In this section, the result obtained from the studies is presented in graph and software application (SketchUp) to ensure the observation and data analysing become easier. Parameters for plant growth (*Carica papaya L.*) are measured consists of height of the plant, the number of leaves, length of leaves and number of the branch using the different ratios of treatments (T).

3.1 Results

3.1.1 Design of the bin

Figure 2 and Figure 3 shows the design of the bins using SketchUp application. There are 2 bins which are Bin 1 and Bin 2. The height of the bins are 34 cm, diameters are 24 cm and 1 cm for hole's diameter of Bin 1. Bin 1 was used to ferment the food waste while Bin 2 was used to drain the liquid from the fermentation process. A hole with 1 cm diameter from Bin 1 to allow the liquid flow into Bin 2 to hold the liquid. A pipe head was used to flow the liquid from the food waste as it can cause rot and bad smell.

Besides, the types of plastic use for the bins are polypropylene (PP). It is strong and can withstand a higher temperature. Thus, it works very well for food containers. It is hard and does not mold in the presence of bacteria or other elements. Also, it is very flexible and lightweight. Then, it is suitable for composting. This bins also easy to purchase at the nearby supermarket or grocery. The available price for Bokashi bin is range from RM50 – RM 100. However, using this bin, it is cheaper within RM30. The design of the bins also easy to handle and practical for the household.

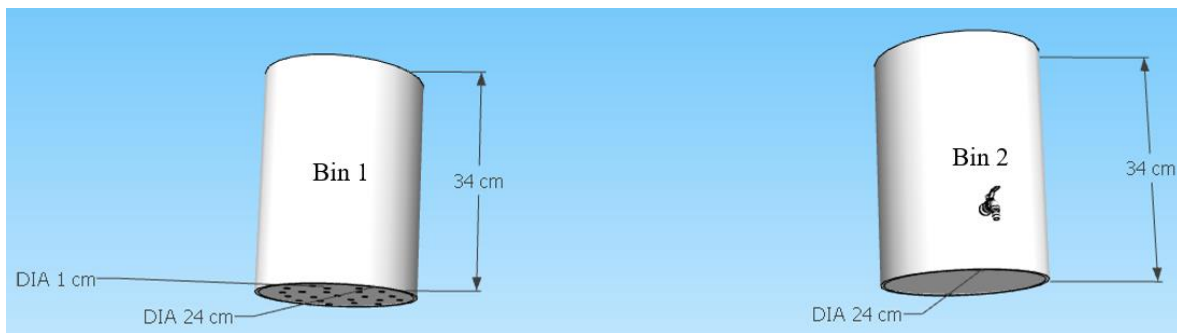

Figure 2: Bin 1 and Bin 2

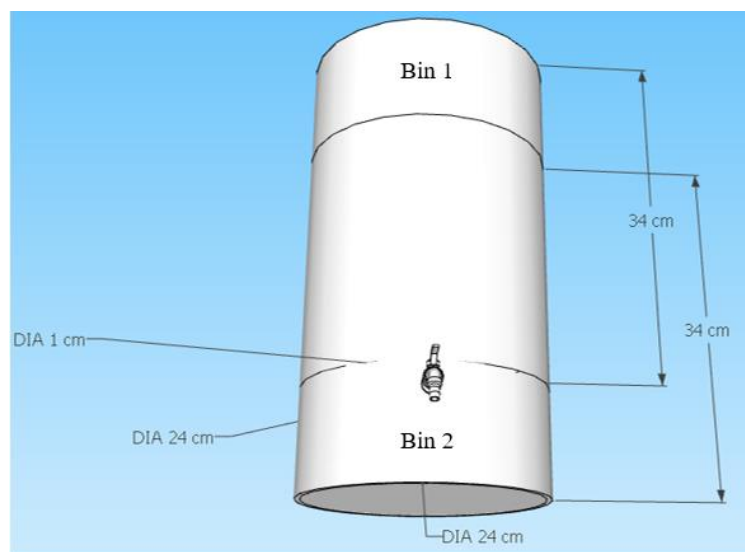

Figure 3: Combination of Bin 1 and Bin 2

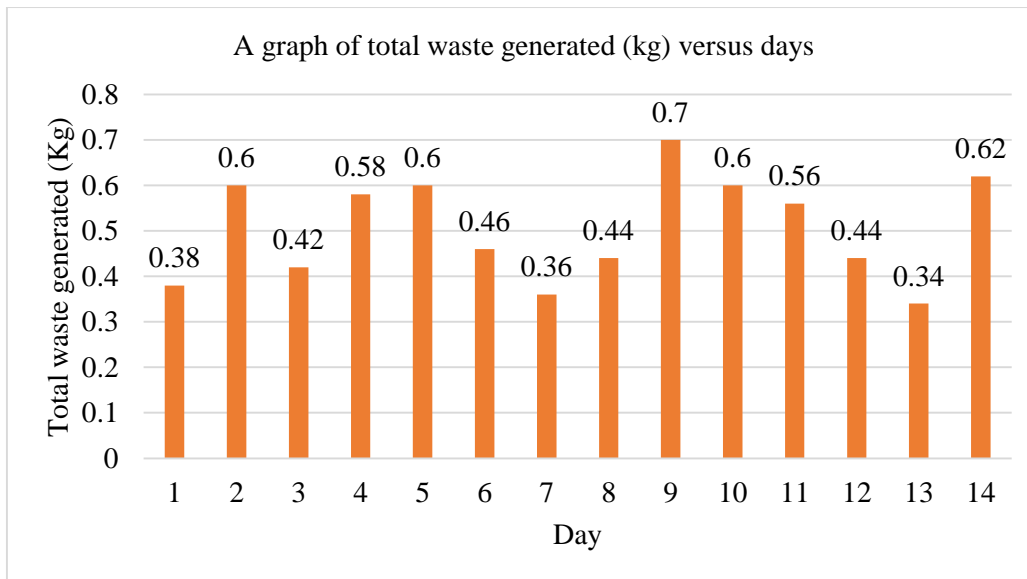

Figure 4: A graph of total waste generated (kg) versus days

Figure 4 show the graph of total waste generated (kg) versus days. The total food waste generated from household for 14 days is 7.10 kg. It showed that day 9 recorded the highest food waste generated (0.70 kg) while the lowest at day 13 recorded the lowest food waste generated (0.34 kg). As the total food waste generated was 7.10 kg for 14 days, then it can hold the wastes around 20 days with an estimated 10.0 kg. Thus, it is suitable for composting process due to economical, easier and available for people to use it.

3.2 Convert the food waste generated from the household via the different EM

Table 2: Formulation of Effective microorganism (EM) Bokashi

| Formulation | Substances | | | |
|-------------|---------------|------------|------------------------------|----------------|
| | Molasses (mL) | Water (mL) | Effective microorganism (mL) | Corn bran (Kg) |
| A | 50 | 200 | 50 | 1 |
| B | 50 | 200 | 100 | 1 |
| C | 50 | 200 | 150 | 1 |

Table 2 show the formulation of effective microorganism (EM) Bokashi. There are three formulations which A, B and C. It shows the materials of corn bran (1 kg), dechlorinated water (200 mL) and molasses (50 mL) are fixed while the amounts of EM are different using 50 mL, 100 mL and 150 mL to find the best formulated EM Bokashi.

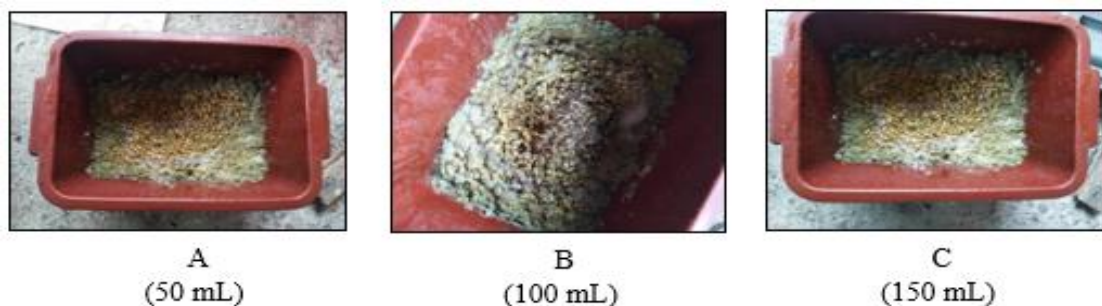

Figure 5: Formulation of A, B and C

Figure 5 shows the formulation of A, B and C. B was chosen as the best formulated EM Bokashi since appearing of more fungi growth and has a smell to vinegar compared to those of A and C. For formulation A, it looked dry and fewer fungi growth while formulation C there was liquify on the container and also fewer fungi growth.



Figure 6: Before and after of fermentation process

After formulation B was selected, it was fermented. Figure 6 shows the before and after the fermentation process. It was sprinkled on the layer of the food waste into an airtight container. It was fermented compost through a fermentation process using EM Bokashi [5]. Fermentation is an anaerobic process which converts the sugar in food waste to acids, gases or alcohol. The microorganism will metabolize nutrients in food waste, then produce carbon dioxide, methane and acids. Bacteria, yeast and fungi will digest organic compound in food waste and produce organic acids such as lactic acid and acetic acid [6].

3.3 Analyse of Bokashi on plant growth (*Carica papaya L.*)

Table 3: Ratios of soil and Bokashi compost

| Treatment (T) | Materials |
|---------------|--|
| T1 | 1 kg of soil |
| T2 | 1 kg of soil + 200 gm of Bokashi compost |
| T3 | 1 kg of soil + 400 gm of Bokashi compost |
| T4 | 1 kg of soil + 600 gm of Bokashi compost |

Table 3 shows the ratios of soil and Bokashi compost were prepared. There are four treatments (T), denote as T1, T2, T3 and T4. For T1 (1 kg of soil), T2 (1 kg of soil and 200 gm of Bokashi compost), T3 (1 kg of soil and 400 gm of Bokashi compost) and T4 (1 kg of soil and 600 gm of Bokashi compost). Four parameters are observed consist of the height of the plant, number of leaves, length of leaves and number of the branch.



Figure 7: Plant growth on *Carica papaya L.*

Figure 7 show the plant growth of T1, T2, T3 and T4. It can be seen that T4 with 1 kg of soil and 600 gm of Bokashi compost more growth compared to those of T1, T2 and T3. Bokashi was applied on plant growth (*Carica papaya L.*) as organic fertilizer for 35 days.

3.3.1 Height of plant (cm)

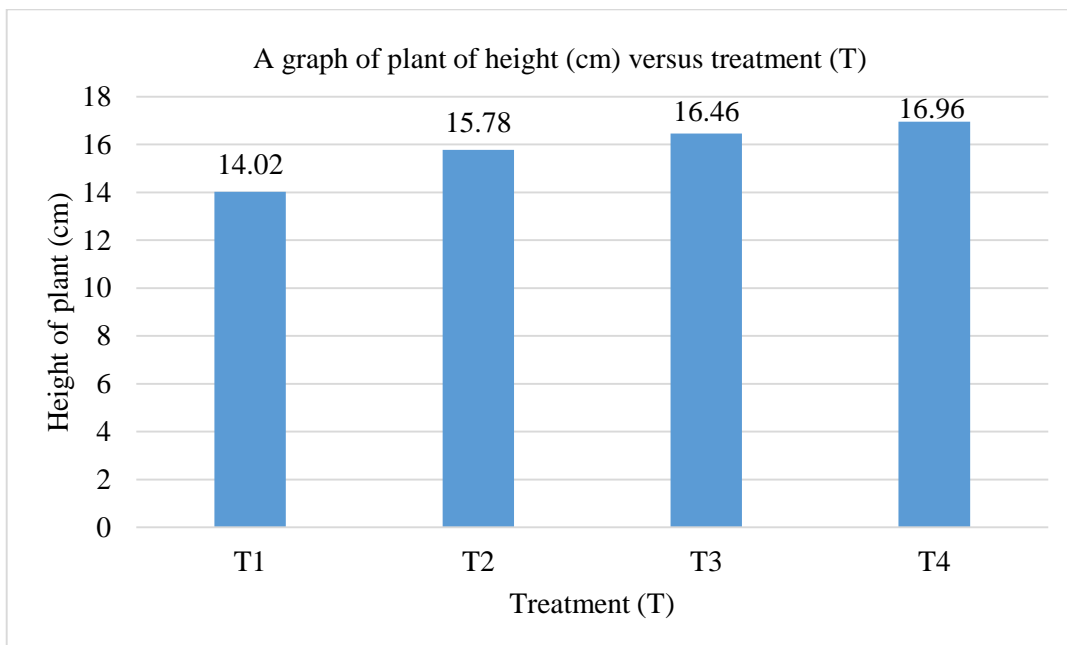

Figure 8: A graph height of the plant versus treatment (T)

Figure 8 shows the graph height of the plant versus treatment (T). T4 (1 kg of soil + 600 gm of Bokashi compost) has the highest mean with 16.96 cm for the height of the plant than other treatments T1 (16.46 cm), T2 (15.78 cm), T3 (14.02 cm). Increasing plant height can be influenced by the increase of nitrogen and carbon as the C/N ratio is important for the growth of the plant [7]. The higher rates of nitrogen will enhance plant height. While the lowest mean height of the plant is T1 (1 kg of soil) with 14.02 cm. The height of the plant is recorded from its base to its highest point. Thus, T4 is the most essential ratio to optimize the growth height of the plant.

3.3.2 Number of leaves

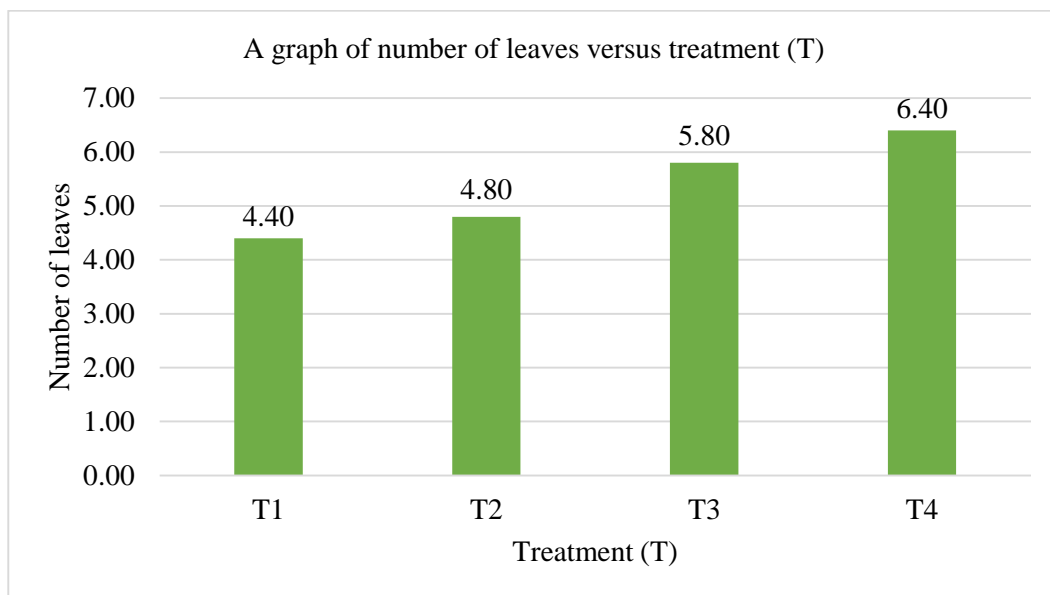

Figure 9: A graph number of leaves versus treatment (T)

Figure 9 shows the number of leaves versus treatment (T). The result shows that T4 is the highest mean with 6.40 for the number of leaves than T1 (4.40), T2 (4.80) and T3 (5.80). For the lowest mean is T1 with 4.40. An increasing number of leaves will indicate better plant growth and development with plant production also will increase. The presence of C/N ratio is needed in a plant to make tissue and a new cell. High nitrogen will reduce the apical dominance and stimulated the development of lateral buds with the production of leaves. Thus, T4 is the best ratio for the number of leaves than other treatment. The number of leaves is counted manually.

3.3.3 Length of leaves (cm)

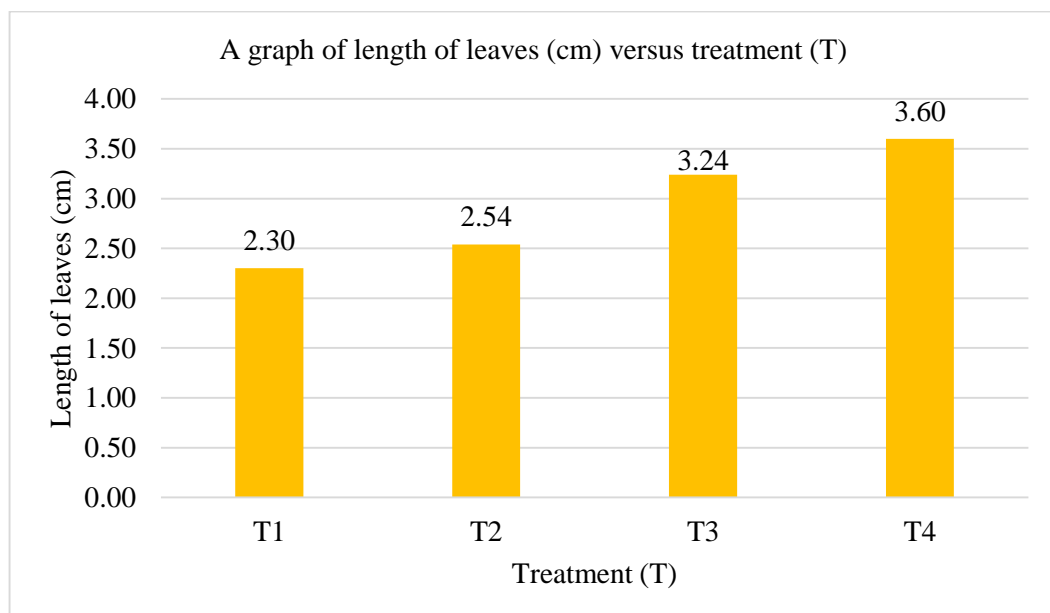

Figure 10: A graph of length of leaves versus treatment (T)

Figure 10 shows the length of leaves versus treatment (T). The best ratio is T4 with mean 3.60 cm when compared to T1 (2.30 cm), T2 (2.54 cm) and T3 (3.24 cm). This showed that T4 has helped for

the growth of the length of leaves. Bokashi is an organic composting that use organic waste to produce compost that has benefits such as has nutrients and increase the organic contents of the soil. For leaf development, nitrogen is available in two forms which are organic and inorganic form. Thus, it is proved that the addition of soil with 1 kg and 600 gm of Bokashi compost has enhanced the plant growth for the length of leaves.

3.3.4 Number of the branch

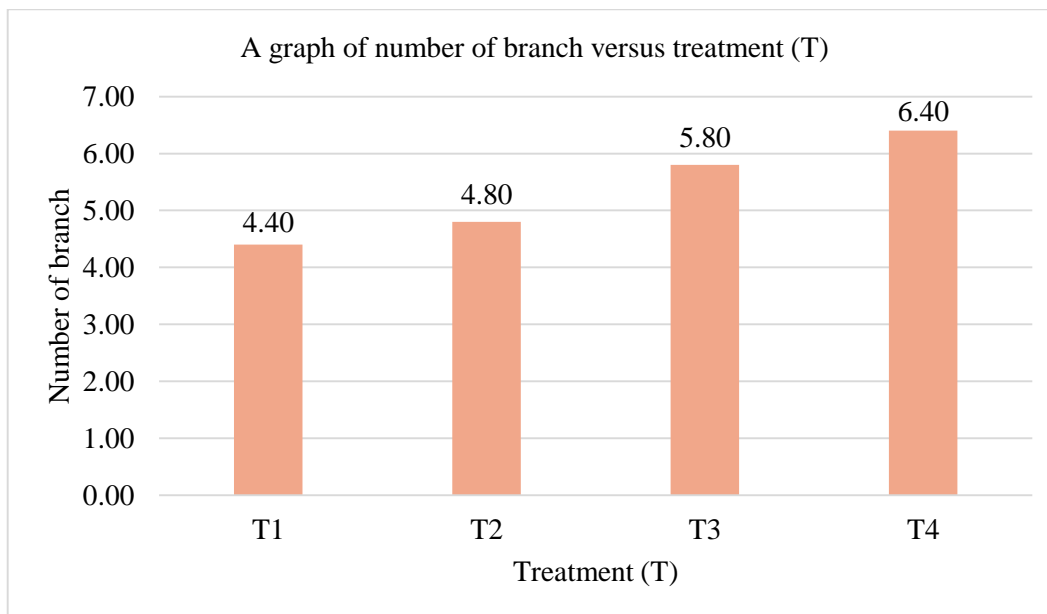

Figure 11: A graph of number of the branch versus treatment (T)

Figure 11 shows the graph number of the branch versus treatment. The highest performance mean is T4 (1 kg of soil + 600 gm of Bokashi compost) with 6.40 while the lowest performance mean is T1 (1 kg of soil) with 4.40. However, T4 is the most suitable for the improvement of the branch even though the difference in T3 is not large. The increasing number of the branch can be influenced by nitrogen due to the increasing of apical branches with higher nitrogen. The use of organic fertilizer is vital to maintain and restore the fertility of soil as it can improve the soil physical, chemical and biological properties through the organic matter [8].

4. Conclusion

In conclusion, the objectives of the study were achieved. A bokashi bin was successfully designed for the household usage, the food waste generated from the household was converted into organic soil fertilizer using a formulation of B and the effect of Bokashi application on papaya trees as organic fertilizer with different ratios and treatments were analysed. There were four treatment, T1 (1 kg of soil), T2 (1 kg of soil + 200 gm of Bokashi compost), T3 (1 kg of soil + 400 gm of Bokashi compost) and T4 (1 kg of soil + 600 gm of Bokashi compost). Through this study, T4 showed the best ratio of Bokashi application on plant growth (*Carica papaya* L.) as organic fertilizer with mean 16.96 cm (height of plant), 6.40 (number of the branch), 3.60 cm (length of leaves) and 6.40 (number of leaves). Therefore, converting food waste generation from household using Bokashi method for composting are able to reduce the wastes and remove the bad odor from food waste. It is a sustainable method, easier and affordable to keep the environment safe.

After conducting this study, there are several recommendations for future experiments that could be made to further the development of the Bachelor Project. The recommendations are to analyse the parameters such as moisture contents, temperature, pH and Carbon to Nitrogen ratio to produce good quality compost. Besides, the mixtures for the formulation of EM Bokashi to be considered well as it

will cause too wet or dry that can affect the EM Bokashi. Next, sprinkling some sugar on food waste to speed up the process of composting. Lastly, laboratory testing should be done to determine the content of the organic fertilizer. The elements that can be tested are Phosphorus, Nitrogen, Potassium, Calcium, Carbon and others.

Acknowledgement

The authors would like to thank the Faculty of Engineering Technology, Universiti Tun Hussein Onn Malaysia (UTHM), for its support.

References

- [1] Ghafar, S. W. A., 2017, "Food Waste in Malaysia : Trends, Current Practices and Key Challenges," FFTC Agricultural Policy Artic., (July), pp. 1–12.
- [2] Lim, W. J., Chin, N. L., Yusof, A. Y., Yahya, A., and Tee, T. P., 2016, "Food Waste Handling in Malaysia and Comparison with Other Asian Countries," Int. Food Res. J., 23(December), pp. S1–S6.
- [3] Sekeli, R., Hamid, M. H., Razak, R. A., Wee, C. Y., and Ong-Abdullah, J., 2018, "Malaysian Carica Papaya l. Var. Eksotika: Current Research Strategies Fronting Challenges," Front. Plant Sci., 9.
- [4] Hamid, H. A., Qi, L. P., Harun, H., Sunar, N. M., Ahmad, F. H., Muhamad, M. S., and Hamidon, N., 2019, "Development of Organic Fertilizer from Food Waste by Composting in UTHM Campus Pagoh," J. Appl. Chem. Nat. Resour., 1(1), pp. 1–6.
- [5] Sunarya, D. S., Nisyawati, and Wardhana, W., 2020, "Utilization of Baglog Waste as Bokashi Fertilizer with Local Microorganisms (MOL) Activator," IOP Conf. Ser. Earth Environ. Sci., 524(1).
- [6] Lih Min, T., 2015, *Production of Fertilizer Using Food Wastes of Vegetables and Fruits Bachelor of Science with Honours (Plant Resource Science and Management) 2015*.
- [7] Ibrahim, M., Rahman, N., and Zain, N., 2018, "Effect of Nitrogen Rates on Growth and Quality of Water Spinach (*Ipomea Aquatica*)," Annu. Res. Rev. Biol., 26(1), pp. 1–12.
- [8] Quiroz, M., and Flores, F., 2019, "Nitrogen Availability, Maturity and Stability of Bokashi-Type Fertilizers Elaborated with Different Feedstocks of Animal Origin," Arch. Agron. Soil Sci., 65(6), pp. 867–875.