

The Development of Smart Parcel Receiver Box

Nur Aqiela Shahira Mohd Tahyuddin¹, Azmanirah Ab Rahman^{1*}, Tamil Selvan Subramaniam¹, Anizam Mohamed Yusof¹

¹Faculty of Technical and Vocational Education,
Universiti Tun Hussein Onn Malaysia Parit Raja, 86400, Johor, MALAYSIA

*Corresponding Author Designation

DOI: <https://doi.org/10.30880/ritvet.2021.01.02.002>

Received 25 August 2021; Accepted 01 September 2021; Available online 28 September 2021

Abstract: Online shopping has become a new trend shopping recently. However, the recipient is often not at home when the items are delivered. This study aims to design, develop, and evaluate a Smart Parcel Receiver Box. The goal of this study is to help recipients keep their packages safe during delivery time. The researcher has used the Engineering Design Project (EDP). EDP includes 5 phases: identification of the problem, analysis of the problem, brainstorming alternative design, modelling the best solution, refinement and retesting the model. To open the box, the sender should ask permission from the receiver by scanning the QR code displayed on the box door. The receiver will permit it by unlocking the door of the box remotely using apps, namely web pages. Overall, the project achieved the objectives of the study. However, there is still space for improvement in terms of product design and apps used.

Keywords: Smart Parcel Receiver Box, Engineering Design Process Model, Web page, QR codes

1. Introduction

Many people today are obsessed with online shopping (Zainudin, 2017). The benefits of online shopping among them are that discreet purchases are easier, save time and save cost compared to conventional shopping (Mujiyana, 2013). Purchasing online is undeniably much easier than buying conventionally because buyers just open the web that provides online sales services, choose items to buy and make a payment (Arisah et. al, 2016). However, there are difficulties during the delivery of goods. Based on the literature four common factors make delivery less efficient as the recipient is not at home during item delivery, difficulty in claiming items at the post office and item loss during delivery. Besides, the items are not suitable to be placed in the mailbox due to size factors (Lipsumtech, 2020; Saharuddin, 2015; Farhan, 2021). Due to that problem, there is a need to develop an innovation of smart parcel receiver that allows users to receive parcels while they are not at home. In turn, it can prevent the loss of consumer goods and consumers no longer must claim postal items at the post office.

There are three main objectives for this research:

- i. Designing smart parcel receiver box using Sketchup software.
- ii. Develop a smart parcel receiver box using the Engineering Design Model.
- iii. Test the functionality of the smart parcel receiver box by using hardware and software analysis methods and IDE software.

2. Methodology

The researcher has used the Engineering Design Project (EDP). Engineering design is a process that begins with an idea and ends with ergonomics to the user (Khandani, 2005). EDP includes 5 phases: identification of the problem, analysis of the problem, brainstorming alternative design, modelling the best solution, refinement and retesting the model. EDP has shown in Figure 1.

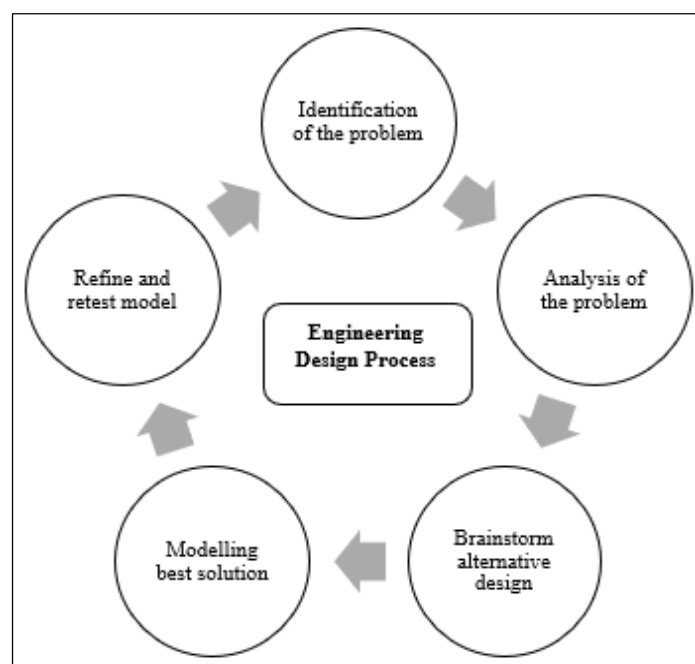

Figure 1: Engineering Design Process Model (EDP)

i. Identify the problem

The first phase is problem identification. The researcher identifies the problem by doing the preliminary study. Based on a study, it was found that the consumer was not at home when the courier service staff sent the parcel (Lipsumtech, 2020). Consumers also face problems such as losing their parcels because the delivery clerk only puts the claim card on the fence of the consumer's house (Saharuddin, 2015). So, the irresponsible person will easily take and claim the parcel at the post office (Farhan, 2021). Hence, the researcher plans to build a Smart Receiver Parcel Box to solve the problems.

ii. Analysis of the problem

The second phase is the problem analysis. The process of analyzing the problem is by obtaining information based on previous studies. Meta-analysis was performed from the aspects of durability, receiver box size and hardware and software suitability (Biru et.al, 2018; Sujitra & Suresh, 2017, Anjali et.al, 2016). The durability aspect is important because the product will be placed outdoors and exposed to erratic weather. In addition, it is necessary to use materials that are not easily broken by irresponsible people. The second thing is to analyze the suitability of the size of the product to be produced because

the average size of goods received by the receiver is not uniform. The third is the hardware and software used in the product development suitable and practical based on articles Babiuch, Foltynek, & Smutny (2019, Khajenasiri (2017), Maier, Sharp, & Vagapov, (2017). Plan & Khandani (2005).

iii. Brainstorm alternative design

The third phase is brainstorming for an alternative design. Product design is planning by selecting appropriate materials to be placed in front of the consumer house. Besides, the size is also suitable for medium-sized parcels. The most important is to design the circuit and the web page user-friendly interface design. Therefore, the best components are selected to ensure that the product works well. First, the researcher sketch design to facilitate the product development process. Figure 2 shows the final sketch for product design.

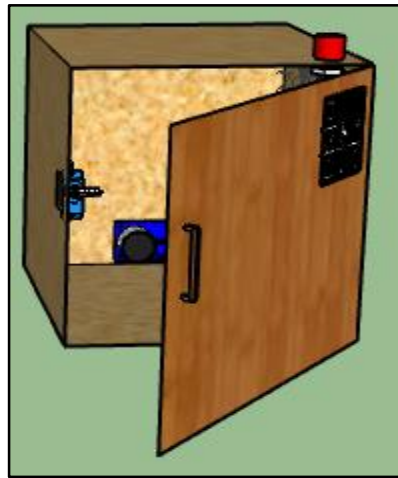

Figure 2: Final Sketch Product Design

iv. Modelling best solution

The modelling phase is the actual product development process consisting of two main processes, namely hardware and software development. The sketch in the pre-design phase is used in the actual product development. Figure 3 shows the block diagram of the Smart Parcel Receiver Box, and Figure 4 shows the whole process in product development and Figure 5 shows the circuit.

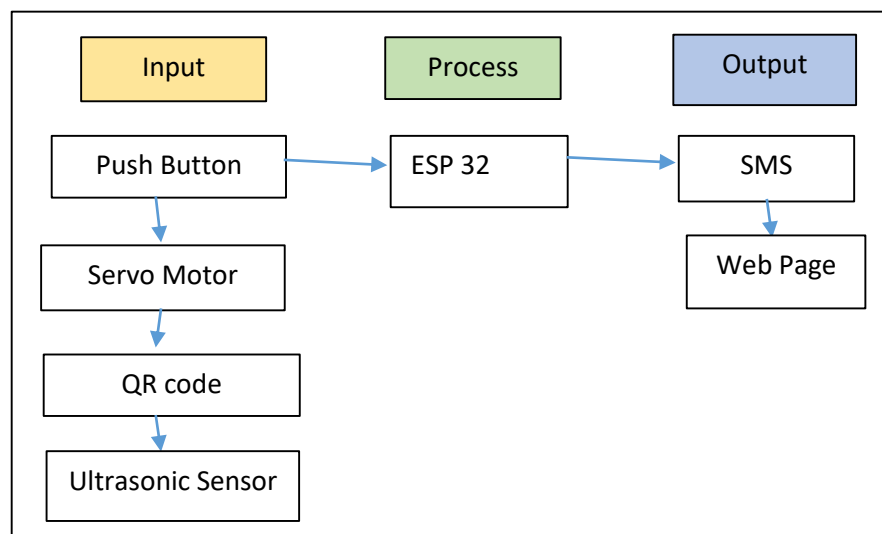

Figure 3: Block diagram of Smart Parcel Receiver Box

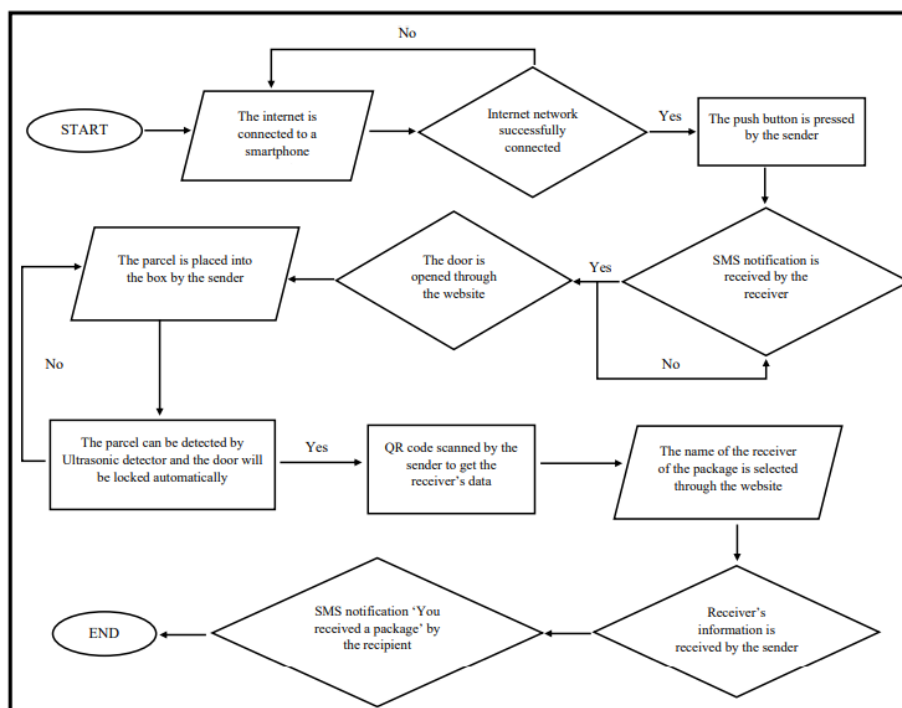

Figure 4: Flow chart of Smart Parcel Receiver Box

a) Hardware Development

- ESP 32 is the main part of the smart parcel receiver box. This system serves to store, send and receive information, and instructions.
- An ultrasonic sensor works to detect the item inserted into the smart parcel receiver box developed.
- The push-button component is connected to the GPIO27 on the ESP32. GPIO27 is used to send orders to customers that need to be received in a smart package recipient box. This push-button connected to the VIN and GPIO27 pins on the ESP32. For servo motor connection as well connected to GPIO13 on ESP32. GPIO13 is used as a locking tool. The box door after the postal parcel is detected next opens the box door after the recipient controls it remotely. This servo motor is connected to the VIN pin, Ground and GPIO13 on ESP32. Finally, the ultrasonic detector component is connected to GPIO12 and GPIO14 on ESP32. The pin is used to track the package pos. These ultrasonic detectors are connected to the VIN, Ground, GPIO12 and GPIO14 pins on the ESP32 module. Table 1 shows the circuit connections on the ESP32.

Table 1: Circuit Connection of ESP32

Component	ESP 32
Push Button	GPIO27
Servo Motor	GPIO13
Ultrasonic Detector	GPIO12 and GPIO14
Vin	3.3 V

b) Software Development

IDE software is used for programming. The program is implemented as the flow chart in Figure 4.

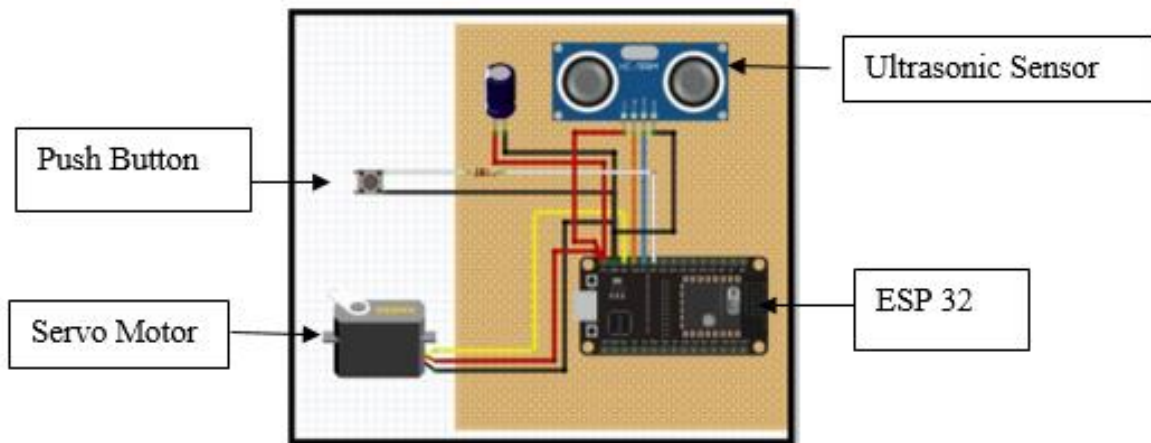

Figure 5: Circuit for Smart Parcel Receiver Box

Finally, the combination of hardware and software was installed on the recipient box as shown in Figure 6.



Figure 6: Final Product of Smart Parcel Receiver Box

c) Refine and Retest Model

The final phase is testing and evaluation. Once the product is fully developed, testing to ensure the functionality of the product. Each process is tested to ensure that all components function well. Testing began with an ESP32 microcontroller, servo motor, pushbuttons, ultrasonic sensors and even an accessible web page. The evaluation of the product requires the confirmation of at least three experts in the product industry. The evaluation aims to ensure that the developed product is in line with the objectives that have been planned and can solve customer problems. The researcher conducted three expert evaluations consisting of electrical and electronic lecturers and assistant engineers at the wiring laboratory.

3. Results and Discussion

Online shopping has become a new trend shopping recently. However, the recipient is often not at home when the items are delivered. This study aims to design, develop, and evaluate a Smart Parcel Receiver Box. The goal of this study is to help recipients keep their packages safe during delivery time. This section will explain the result and discuss the analysis of (i) process of Smart Receiver Parcel Box (ii) effectiveness of ultrasonic sensor and servo motor and (iii) Analysis of the distance of ESP32

connected with internet modem. Table 2 shows the process of Smart Receiver Parcel Box when sender send items.

Table 2: Analysis of Smart Receiver Parcel Box





Process	Description
 <p>1) The push button is pressed to request the recipient to place the item in the receiver box</p>	 <p>2) The SMS received by the recipient. The recipient will press the IP address to unlock the door remotely.</p>
 <p>3) The display of the web page is used by the recipient to unlock the door remotely by entering the correct input password. The open button is pressed, and the door of the receiver box will open.</p>	 <p>4) The smart receiver box is in an open state when the servo motor receives instruction from the recipient. When the door opens the item can be placed into the box by the sender. After the package is detected, the box door is closed and re-locked automatically.</p>
 <p>5) The web page is used for the sender to scan the QR code displayed on the box door.</p>	 <p>6) The display of the SMS received by the recipient after the package the post is placed into the box as well after the sender gets the recipient information.</p>

Table 3 shows the test of the effectiveness of the ultrasonic sensor and servo motor. For distances between 10 cm, 15 cm and 20 cm detected by the ultrasonic sensor the servo motor is in the lock state while for distances between 25 cm to 40 cm the servo motor is in the unlock state.

Table 3: Effectiveness of ultrasonic sensor and servo motor

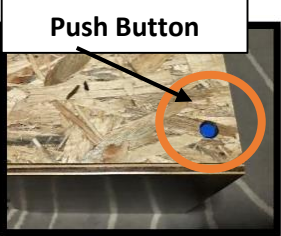
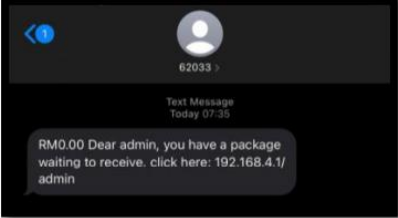
Distance (cm)	Detect (Ultrasonic Sensor)	Servo Motor
0	No	Unlock
5	No	Unlock
10	Yes	Lock
15	Yes	Lock
20	Yes	Lock
25	No	Unlock
30	No	Unlock
35	No	Unlock
40	No	Unlock

In the product development of smart parcel receiver boxes, ESP32 was used to send, receive, process and store data as well as control servo motors by using a web page. Therefore, researchers have conducted a test on the strength of Wi-Fi between ESP32 and internet modem. The test was performed by determining the maximum distance between these two devices. Table 4 shows the analysis of the distance of ESP 32 with internet modem compared to RSSI. RSSI is a measurement of how well your device can hear a signal from an access point or router. It's a value that is useful for determining if you have enough signal to get a good wireless connection. RSSI value is measured in decibels from 0 (zero) to -120. The closer the value to 0 (zero), the stronger the signal will be (Rivasplata, 2019). Based on the result obtained, for distance from 10 m to 90 m the RSSI reading is between -47dBm to -63 dBm and the status is very good. For distance 120m the RSSI reading is good. For distance 150 m above the signal is unusable.

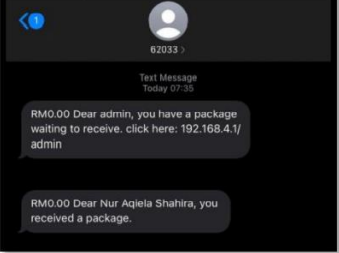
Table 4: Analysis of the distance of ESP32 connected with internet modem

Distance (m)	RSSI (dBm)	Status
10m	-47	Very good
30m	-52	Very good
60m	-57	Very good
90m	-63	Very Good
120m	-77	Good
150m	-	Disconnected
180m	-	Disconnected
200m	-	Disconnected

Apart from the testing process, the researcher has also made validation with the electrical and electronic experts in terms of product design, and functionality. There are four items for the product design domain namely design, physical size, user friendly and component arrangement. There are five items to test the functionality of the product as a whole, QR code functionality, web page functionality, pushbutton functionality and the functionality of the recipient in receiving SMS. All items are specified in the form of Checklist. Based on the validity of the experts, all experts agree that the products developed have achieved the objectives of the study and the products can function well and effectively. Therefore, some experts comment and suggest improving the selection of durable materials for the product frame design. In addition, it further enhances the security of the postal package acceptance process by adding a closed-circuit security camera (CCTV). Finally, the use of solar energy needs to be improved as the product will be placed outside the customer's house.

4. Conclusion

In conclusion, the development of this smart parcel receiver box fulfils all the objectives which are to design a smart parcel receiver box using Internet of Things (IoT) technology. Besides, all the experts

agreed that this product can fully function according to its functionality. Therefore, all the suggestions and recommendations given by the experts are taken into consideration for the improvement of the product in future research. Overall, this product could help the users receive their parcel by controlling the door of the box during the delivery time. At the same time, the user's parcel safety is more guaranteed with the door locked and SMS notification when the parcel arrives and is received.

Acknowledgement

The author would like to express appreciation to the Faculty of Technical and Vocational Education, Universiti Tun Hussein Onn Malaysia and Ministry of Higher Education (MOHE) for supporting this research.

References

- Anjali, P., Pujari, D., Bansode, P., Girme, P., Mohite, H., & Pande, A. (2016). Smart Letter Box System Using Obstacle Sensor for Notifies the User by Android Application B. *Android Application*, 823–825
- Arisah, F. M., Azahari, S., Badari, Z., & Hashim, H. (2016). Amalan Pembelian Secara Atas Talian dan Faktor- - Faktor Mempengaruhi 1(3), 111–123.
- Babiuch, M., Folytnyk, P., & Smutny, P. (2019). Using the ESP32 microcontroller for data processing. *Proceedings of the 2019 20th International Carpathian Control Conference, ICCCC 2019*, 0–5. <https://doi.org/10.1109/CarpathianCC.2019.8765944>
- Biru, Z., Nukuro, D., & Haghani, S. (2018). The Design and Implementation of an Intelligent Letter Box Design and Implementation of an Intelligent Letter box.
- Farhan. (2021, Mac 25). Apa Perlu Buat Apabila Barang Anda Hilang Atau Tidak Sampai. Retrieved from <https://rentassempadan.com/apa-perlu-buat-apabila-barang-anda-hilang-atau-tidak-sampai/>
- Khajenasiri, I., Estebarsari, A., Verhelst, M., & Gielen, G. (2017). A Review on Internet of Things Solutions for Intelligent Energy Control in Buildings for Smart City Applications. *Energy Procedia*, 111(September 2016), 770–779. <https://doi.org/10.1016/j.egypro.2017.03.239>
- Khandani, S. (2005). *Engineering Design Process*. Education Transfer Plan, 4-5.
- Lipsumtech. (2020). Persaingan locker pintar juga dapat memberikan hasil yang tidak dijangka. Retrieved from <https://ms.lipsumtech.com/smart-locker-competition-may-also-deliver-unexpected-outcomes-955140>
- Maier, A., Sharp, A., & Vagapov, Y. (2017). Comparative analysis and practical implementation of the ESP32 microcontroller module for the internet of things. *2017 Internet Technologies and Applications, ITA 2017 - Proceedings of the 7th International Conference*, 143–148. <https://doi.org/10.1109/ITECHA.2017.8101926>
- Mujiyana, I. E. (2013). Analisis Faktor-Faktor Yang Mempengaruhi Keputusan Pembelian Via Internet Pada Toko Online. 145.
- Plan, E. T., & Khandani, S. (2005). Prepared by, (August), 1–24. RandomNerd. (2019). ESP32 Web Server – Arduino IDE. Retrieved from <https://randomnerdtutorials.com/esp32-web-server-arduino-ide/>

- Pragati, G. Bansode, P. Mohite, H. Pande, A. (2017) Implementation of Smart Letter Box System. Retrieved from [http://ijaricee.com/AdminUploadPdf/Implementation_of_Smart_Letter_Box\)System_ijarie5480.pdf](http://ijaricee.com/AdminUploadPdf/Implementation_of_Smart_Letter_Box)System_ijarie5480.pdf)
- Rivaplasta, F. (2019) What is RSSI and what does it mean for a WiFi network? Retrieved from https://www.spacewalkers.com/wpcontent/uploads/cma_attachments/1553784033906_Understanding-and-Checking-the-Stellar-RSSI.pdf
- Saharudin, E. (2015, November 25). uCella – Peti Surat Pintar Memudahkan Penerimaan Bungkus Di Rumah. Retrieved from <https://amanz.my/2015100231/>
- Sujithra, T., & Suresh, A. (2017). Automation of Parcel Delivery Collection Using IOT – SMART FREIGHT, 8(9), 966–972
- Zainuddin, M. Z. (2017, November 12). Rakyat Malaysia paling ramai beli dalam talian. Retrieved from <https://origin.bharian.com.my/bisnes/teknologi/2017/11/349820/rakyat-malaysia-paling-ramai-beli-dalam-talian>